

GBC 4064WF-1

INSTALLATION & OPERATING MANUAL

Part Number: TBD, Rev A.



Part Number: TBD

GB	Operating Instructions
I	Istruzioni per l'Uso
D	Bedienungsanleitungen
NL	Gebruiksaanwijzing
F	Mode d'Emploi
E	Instrucciones de Operación

GB

The information in this publication is provided for reference and is believed to be accurate and complete. General Binding Corporation (GBC) is not liable for errors in this publication or for incidental or consequential damage in connection with the furnishing or use of the information in this publication, including, but not limited to, any implied warranty of fitness or merchantability for any particular use.

GBC reserves the right to make changes to this publication and to the products described in it without notice. All specifications and information concerning products are subject to change without notice. Reference in this publication to information or products protected by copyright or patent does not convey any license under the rights of GBC or others. GBC assumes no liability arising from infringements of patents or any other rights of third parties.

This publication is copyrighted © 2006 by GBC. All rights reserved. The information contained in this publication is proprietary and may not be reproduced, stored, transmitted, or transferred, in whole or in part, in any form without the prior and express written permission of GBC.

I

Le informazioni contenute in questo documento sono fornite a titolo di referenza e sono considerate corrette e complete. General Binding Corporation (GBC) non si responsabilizza di eventuali errori contenuti in questo documento, né di danni incidentali o conseguenti relazionati con la fornitura e l'uso delle informazioni in questo documento, includendo senza limitazioni qualsiasi garanzia d'idoneità o commerciabilità per qualsiasi uso particolare.

GBC si riserva il diritto di effettuare cambi a questo documento e ai prodotti in esso descritti senza preavviso. Tutte le specifiche e le informazioni sui prodotti sono soggette a cambio senza preavviso.

In questo documento le referenze a informazioni e prodotti protetti da diritti di proprietà intellettuale o brevetti non trasferiscono nessuna licenza alla quale abbiano diritto GBC o altri. GBC non assume nessuna responsabilità derivante dalla violazione di brevetti o di qualsiasi altro diritto di terzi.

Copyright © 2006 Questo documento è soggetto ai diritti di proprietà intellettuale di GBC. Riservati tutti i diritti. Le informazioni contenute in questo documento sono di proprietà esclusiva e non possono essere riprodotte, conservate, trasferite, in tutto o in parte ed in modo alcuno, senza la previa autorizzazione espressa e per iscritto di GBC.

D

Die Informationen in dieser Druckschrift werden als Richtlinien zur Verfügung gestellt und sind unseres Wissens richtig und vollständig. General Binding Corporation (GBC) lehnt jede Haftung für Fehler in dieser Druckschrift sowie für Schadenersatz oder Folgeschäden im Zusammenhang mit der Bereitstellung oder Verwendung der hierin enthaltenen Informationen ab, ein- aber nicht ausschließlich die Gewährleistung für Eignung und handelsübliche Qualität für einen bestimmten Zweck.

GBS behält sich das Recht vor, diese Druckschrift und die darin beschriebenen Produkte ohne Vorankündigung zu ändern. Alle die Produkte betreffenden Leistungsbeschreibungen und Informationen können jederzeit ohne Vorankündigung geändert werden.

Durch die Bezugnahmen in dieser Druckschrift auf urheberrechtlich oder durch ein Patent geschützte Informationen oder Produkte werden keine Rechte von GBC oder Dritten übertragen. GBC lehnt jede Haftung für Patentverletzungen sowie für die Verletzung anderer Rechte von Dritten ab.

Diese Druckschrift ist durch GBC urheberrechtlich geschützt (© 2006). Alle Rechte vorbehalten. Die Informationen in dieser Druckschrift sind gesetzlich geschützt und dürfen ohne vorherige und ausdrückliche schriftliche Genehmigung von GBC in keiner Weise weder ganz noch teilweise vervielfältigt, aufbewahrt, weiter verbreitet oder übertragen werden.

NL

De informatie in deze publicatie geldt slechts ter verwijzing en wordt nauwkeurig en volledig geacht. General Binding Corporation (GBC) is niet aansprakelijk voor fouten in deze publicatie of voor incidentele of voortvloeiende schade in verband met het verschaffen of gebruik van de informatie in deze publicatie, inclusief, maar niet beperkt tot stilzwijgende garanties van geschiktheid voor een bepaald doel of verkoopbaarheid.

GBC behoudt zich het recht voor om zonder voorafgaande kennisgeving wijzigingen te maken in deze publicatie en in de producten die hierin worden beschreven. Alle specificaties en informatie m.b.t. producten kunnen zonder voorafgaande kennisgeving gewijzigd worden.

Verwijzingen in deze publicatie naar informatie of producten beschermd door copyrights of patenten houdt geen licenties onder de rechten van GBC of anderen in. GBC is niet aansprakelijk voor schendingen van patenten of andere rechten van derden.

De publicatie is auteursrechtelijk beschermd, copyright © 2006 door GBC. Alle rechten voorbehouden. De informatie in deze publicatie is eigendom van GBC en mag niet verveelvuldigd, opgeslagen, overgebracht of overgedragen worden, geheel of gedeeltelijk, in welke vorm dan ook zonder voorafgaande en uitdrukkelijke schriftelijke toestemming van GBC.

F

L'information contenue dans cette publication est fournie à titre de référence et elle est considérée exacte et complète. General Binding Corporation (GBC) n'est pas responsable des erreurs contenues dans cette publication ni des dommages indirects ou consécutifs portant sur l'utilisation ou la présentation de l'information de ce document, y compris, mais sans s'y limiter, toute garantie implicite de commercialité ou d'adaptation à un usage particulier.

GBC se réserve le droit d'apporter des modifications à cette publication et aux produits qui y sont décrits sans préavis. Toutes les spécifications et l'information au sujet des produits sont sujettes à changements sans préavis.

Toute référence à l'information ou aux produits protégés par un droit d'auteur ou un brevet présentée dans ce document ne porte aucune licence sous les droits de GBC ou d'autres parties. GBC n'assume aucune responsabilité découlant de contraventions aux brevets ou à tout autre droit de tierces parties.

Cette publication est protégée par un droit d'auteur © 2006 de GBC. Tous droits réservés L'information contenue dans cette publication est privative et ne peut pas être reproduite, mise en mémoire, transmise ou transférée, en partie ou en entier, sous quelque forme que ce soit sans la permission écrite préalable et expresse de GBC.

E

La información contenida en esta publicación es proporcionada a título de referencia y se considera que es precisa y completa. General Binding Corporation (GBC) no es responsable por errores contenidos en esta publicación o por daños consecuentes o incidentales relacionados con la disponibilidad o el uso de la información en esta publicación, incluyendo y sin limitarse a, cualquier garantía de aptitud y comerciabilidad para cualquier uso específico.

GBC se reserva el derecho de hacer cambios en esta publicación y a los productos descritos en la misma sin aviso previo. Todas las características y la información referente a los productos, están sujetas a cambios sin aviso previo.

Las referencias en esta publicación a información o productos protegidos por derechos de propiedad intelectual o por patentes no otorga ninguna licencia amparada por los derechos de GBC u otros. GBC no asume ninguna responsabilidad que se derive de la violación de patentes u otros derechos de terceras partes.

Copyright © 2006 Esta publicación está amparada por derechos de propiedad intelectual de GBC. Todos los derechos reservados. La información contenida en este documento es de propiedad exclusiva y no puede reproducirse, almacenarse, transmitirse o transferirse, en su totalidad o en partes, y de ninguna manera, sin la autorización previa y por escrito de GBC.

TABLE OF CONTENTS

Description	Page No.	Description	Page No.
Cover	1	Sequence of Operations	16
Legal Disclaimer	2	Operating Instructions	17
Table of Contents	3	Film Loading and Threading	17
Important Safety Instructions	4	Load a Roll of Film	17
Important Safeguards	4	Webbing Thermal Film using Threading Card	18
General ,Electric & Service		Webbing PSA Film / Mount Adhesive Using Threading Card	19
Warranty	5	Start Laminating	20
Specifications	5	Method for Tacking new Film to Existing Film	21
Pre- Installation	6	To Unweb The Laminator	22
Installation	6	Clearing a Film Jam (Wrap- Up)	22
Front Control Guide	7	Applications	23
Lamination Processes	8	Pre-Coating Boards	23
Selecting Gaps and Pressures	8	Mounting Pre-Coated Boards	23
AccuShield Mode	9	Single Sided Lamination	23
Saving Temps and Speeds	10	Creating a Decal	24
LCD Quick Reference	11	Mounting a Decal	24
LCD Detailed Reference Sheet	12	Thermal Encapsulation	24
Features Guide	13	AccuShield™	25
Emergency-Stop Buttons	13	2-Sided PSA	26
Heated Main Roll-Top	13	1-Sided PSA	27
Heated Main Roll-Bottom	13	2-Side Thermal	28
Media Pressure Plate	13	PSA Decal	29
Front Table	13	PSA Mounting	30
Table Idler	13	Speed/Temperature Control	31
Safety Light Beam System	13	The Art of Lamination	31
Rewinder Tubes	13	Basic Rules	31
Upper Tension Idler Bar	13	Film Tension	31
Rewinder Clutch Adjustment	13	Heat	32
Nip Pressure Gauge	13	Output	32
Pneumatic Adjustment Knob	13	Maintenance	33
Main Air Supply	14	Trouble Shooting Guide	34
Tension Knobs	14	Service Agreement	34
Swing Out Film Shafts	14		
Core Chucks	14		
Upper Pull Roller	14		
Lower Pull Roller	14		
Rear Table	14		
Safety Interlock Switch	14		
Rear Slitter	14		
Rear Slitter Track	14		
Rear Table Media Idler	14		
In-Line Slitters	14		
Slitter Blade	14		
Slitter Bar Mounting	14		
Pull Roller Clutch	15		
Main Circuit Breaker	15		
Fuses	15		
Foot Switch	15		
Power Cord	15		

IMPORTANT SAFETY INSTRUCTIONS

YOUR SAFETY AS WELL AS THE SAFETY OF OTHERS IS IMPORTANT TO GBC. IN THIS INSTRUCTION MANUAL AND ON THE PRODUCT, YOU WILL FIND IMPORTANT SAFETY MESSAGES REGARDING THE PRODUCT. READ THESE MESSAGES CAREFULLY. READ ALL OF THE INSTRUCTIONS AND SAVE THESE INSTRUCTIONS FOR LATER USE.



THE SAFETY ALERT SYMBOL PRECEDES EACH SAFETY MESSAGE IN THIS INSTRUCTION MANUAL. THE SYMBOL INDICATES A POTENTIAL PERSONAL SAFETY HAZARD TO YOU OR OTHERS. THE FOLLOWING WARNINGS ARE FOUND UPON THIS PRODUCT.

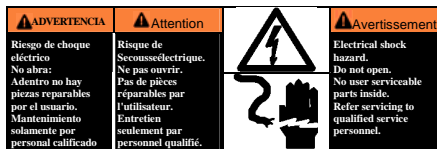

THIS SAFETY MESSAGE MEANS THAT YOU COULD BE SERIOUSLY HURT OR KILLED IF YOU OPEN THE PRODUCT AND EXPOSE YOURSELF TO HAZARDOUS VOLTAGE.



THIS SAFETY MESSAGE MEANS THAT YOU COULD BE BURNED AND YOUR FINGERS COULD BE TRAPPED AND CRUSHED IN THE HOT ROLLERS. CLOTHING, JEWELRY AND LONG HAIR COULD BE CAUGHT IN THE ROLLERS AND PULL YOU INTO THEM.



THIS SAFETY MESSAGE MEANS THAT YOU COULD CUT YOURSELF IF YOU ARE NOT CAREFUL.



WARNING: THIS SAFETY ALERT SYMBOL PRECEDES EACH SAFETY MESSAGE IN THIS INSTRUCTION MANUAL. THE SYMBOL INDICATES A POTENTIAL PERSONAL SAFETY HAZARD TO YOU OR OTHERS.



WARNING: DO NOT ATTEMPT TO SERVICE OR REPAIR THE 4064-1 WF LAMINATOR.



WARNING: DO NOT CONNECT THE LAMINATOR TO AN ELECTRICAL SUPPLY OR ATTEMPT TO OPERATE THE LAMINATOR UNTIL YOU HAVE COMPLETELY READ THESE INSTRUCTIONS. MAINTAIN THESE INSTRUCTIONS IN A CONVENIENT LOCATION FOR FUTURE REFERENCE.

IMPORTANT SAFEGUARDS



WARNING: TO GUARD AGAINST INJURY THE FOLLOWING SAFETY PRECAUTIONS MUST BE OBSERVED IN INSTALLATION AND USE OF THE LAMINATOR.

General:

Keep hands, long hair, loose clothing, and articles such as necklaces or ties away from the front of the heat and pull rollers to avoid entanglement and entrapment.

The heat rollers can reach temperatures over 300°F (150°C). Avoid contact with the heat rollers during operation or shortly after power has been removed from the laminator.

Keep hands and fingers away from the path of the sharp film cutter blades.

Do not use the laminator for other than its intended purpose.

Avoid moving the Laminator on uneven floor surfaces. Never tilt the laminator.

Do not defeat or remove electrical and mechanical safety equipment such as interlocks, shields and guards.

Do not insert objects unsuitable for laminating or expose the equipment to liquids.

Electrical:

The Laminator should be connected only to a source of power as indicated in these instructions and on the serial plate located on the rear of the laminator. Contact an electrician should the attachment plug provided with the Laminator not match the receptacles at your location.



WARNING: THE RECEPTACLE MUST BE LOCATED NEAR THE EQUIPMENT AND EASILY ACCESSIBLE.

Do not operate the Laminator with a damaged power supply cord or attachment plug, upon occurrence of a malfunction, or after the laminator has been damaged. Contact GBC's Technical Service Department or your dealer/distributor for assistance.

Service:

Perform only the routine maintenance procedures referred to in these instructions



WARNING: DO NOT ATTEMPT TO SERVICE OR REPAIR THE LAMINATOR

Disconnect the plug from the receptacle and contact GBC's Technical Department or your dealer/distributor when one or more of the following has occurred.

- The power supply cord or attachment plug is damaged.
- Liquid has been spilled into the laminator.
- The laminator is malfunctioning after being mishandled.
- The laminator does not operate as described in these instructions.

WARRANTY

Limited 90- Day Warranty

GBC warrants to the original purchaser for a period of ninety days on labor and one year on parts after installation that this laminator is free from defects in workmanship and material under normal use and service. GBC's obligation under this limited warranty is limited to replacement or repair, at GBC's option, of any part found defective by GBC without charge for material or labor.

THIS LIMITED WARRANTY IS IN LIEU OF ALL OTHER WARRANTIES EXPRESSED OR IMPLIED. WARRANTIES OF MERCHANTABILITY OR FITNESS FOR A PARTICULAR PURPOSE ARE EXPRESSLY EXCLUDED. ANY REPRESENTATIONS OR PROMISES INCONSISTENT WITH, OR IN ADDITION TO, THIS LIMITED WARRANTY ARE UNAUTHORIZED AND SHALL NOT BE BINDING UPON GBC. IN NO EVENT SHALL GBC BE LIABLE FOR ANY SPECIAL, INCIDENTAL, OR CONSEQUENTIAL DAMAGES, WHETHER OR NOT FORESEEABLE.

This limited warranty shall be void if the laminator has been misused; mishandled; damaged by negligence, by accident, during shipment, or due to exposure to extreme conditions; repaired, altered, moved, or installed by anyone other than GBC or its authorized agents; or if incompatible film was used. GBC's obligation under this limited warranty does not include routine maintenance, cleaning, adjustment, normal cosmetic or mechanical wear, or freight charges.

Without limiting the generality of the previous paragraph, GBC's obligation under this limited warranty does not include:

1. Damage caused to the rollers by knives, razors, or other sharp tools: by any foreign objects falling into the working area of the laminator; or by cleaning the laminator with solutions or materials that harm its surfaces;
2. Damage caused by adhesives; nor
3. Damage caused by lifting, tilting or attempting to position the laminator other than rolling it on its castors across even surfaces.

FOR EUROPEAN UNION RESIDENTS ONLY: This guarantee does not affect the legal rights which consumers have under applicable national legislation governing the sale of consumer goods.

SPECIFICATIONS

Agency Approval	cULus
Operating Speed	Up to 20fpm MAX
Maximum Temperature	300°F (150°C)
Maximum Mounting Thickness	Main Roller-1 in. (25.4 mm) Max. Pull Roller-1 in. (25.4 mm) Working gap. 1 in. total opening gap.
Maximum Film Width	64 in. (162.5 cm)
Dimensions (W x D x H)	Unit alone: (Uncrated) 82.5in x 41in. x 54in. (209cm x 104cm x 137cm.) Depth of 4064-1 is 44.4 in (112 cm) with tables in up position.
Weight	Unit alone: 1500 lb (680 Kg). Shipping: 1700 lb (771 Kg).
Electrical Requirements	Refer to the serial plate located on the rear of the laminator for the specific electrical rating applicable to the unit.
US Models-	220V, 40Amps, 60 HZ. Single Phase. 8500Watts
CE Models-	380VAC, 13Amps, 50HZ. 3 Phase, 8500 Watts
FCC NOTE	<p>FCC Class A Notice - Notification pour les Etats-Unis</p> <p>Note: This equipment has been tested and found to comply with the limits for a Class A digital device, pursuant to part 15 of the FCC rules. These limits are designed to provide reasonable protection against harmful interference when the equipment is operated in a commercial environment. This equipment generates, uses, and can radiated radio frequency energy and, if not installed and used in accordance with the instruction manual, may cause harmful interference to radio communications. Operation of this equipment in a residential area is likely to cause harmful interference in which case the user will be required to correct the interference at their own expense.</p> <p>Canada Class A Notice - Avis Canada, Class A</p> <p>This Class A digital apparatus complies with Canadian ICES-003. Cet appareil numérique de la classe A est conforme à la norme NMB-003 du Canada.</p> <p>Modifications</p> <p>Any modifications made to this device that are not approved by General Binding Corporation may void the authority granted to the user by the FCC and/or by Industry Canada to operate this equipment.</p> <p>Toutes modifications apportées à ce dispositif et non approuvées par General Binding Corporation annuleront le droit accordé à l'utilisateur par le FCC et/ou par Industrie Canada de faire fonctionner cet équipement.</p>

PRE-INSTALLATION

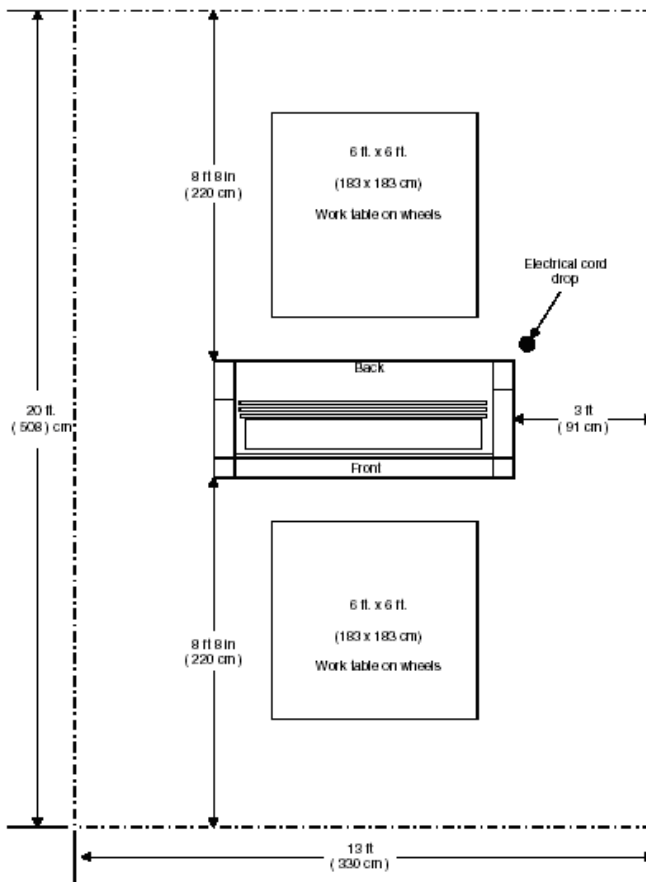

Before a 4064WF-1 Laminator can be installed, ensure the following requirements are met:

1. Are doorways and hallways wide enough for the laminator to be moved to the installation site?
2. Is there ample room for the laminator?
 - A work area must be established that allows for operation in both the front and rear of the laminator and provides space for efficient material flow.
3. Is the environment appropriate for the laminator?
 - The laminator requires a clean, dust and vapor free environment to operate properly.
 - Avoid locating the laminator near sources of heat or cold. Avoid locating the laminator in the direct path of forced, heated or cooled air.

CAUTION: Air flow can cause uneven heating / cooling of the rollers and result in poor output quality.

4. Have you contacted a certified electrician to wire the receptacle and ensure that adequate power is being supplied, having the appropriate capacity, over current protection and safety lockouts available?

GBC 4064WF-1 Requires:

- 220V at 60Hz with 40 amps single phase.
- Nema 6-50 P 50 A 250 V Receptacle

This Machine is supplied with a Nema 6-50 male plug.

INSTALLATION

1. Shipping damage should be brought to the immediate attention of the delivering carrier.
2. With assistance, carefully roll the laminator into position over flat and even surfaces.
3. The laminator should be positioned to allow exiting film to flow freely to the floor or a work table. Accumulation of laminate immediately behind the laminator as it exits the equipment may cause the film to wrap around the pull rollers, resulting in a "jammed" condition.
4. Avoid locating the laminator near sources of heat or cold. Avoid locating the laminator in the direct path of forced, heated or cooled air.
5. Once the laminator has been properly positioned, lock the castors in place. Locking the castors prevent the machine from rolling during set up, operation or servicing.
6. Connect the attachment plug provided with the laminator to a suitably grounded outlet. Avoid connecting other equipment to the same branch circuit to which the laminator is connected, as this may result in nuisance tripping of circuit breakers or blowing fuses.

Note: Machine must be leveled to ensure best performance. Level the machine by lowering both the main and pull rolls. Lay a level on top of the main and pull rolls. Then, check level from main roll to pull roll on right and left side of the roll. Finally, check by placing the level diagonally across lower main to lower pull rolls.

FRONT CONTROL GUIDE

FIGURE 1.

**1. LCD:**

- The LCD will display the settings the machine is currently set for.
- Illuminates when the laminator is plugged in and **POWER ON/OFF** is in the on, (I), position. Displays settings for the top heater, bottom heater, speed, job mode, and ready/wait.
- TOP: -refers to the Top Main Rollers temperatures setting.
- BOT: - refers to the Bottom Main Rollers temperatures setting.
- Mode: -Displays the current Machines Mode. It will read either FWD or REV.
- Speed: Will display the set speed.
- POS: Will indicate the roll gap or position.

2. Top Set Temp:

- This will display the “Set Temp.” of the Top Main Roller.

3. Bottom Set Temp:

- This will display the “Set Temp.” of the Bottom Main Roller.

4. Speed:

- This will display the “Set Speed.” of the Laminator.

5. Job Mode:

- When pressed, the Job Selection will activate. By rotating the Master Dial, You can select the Job Needed. When Job Save is pressed and held, the current job settings will save for that Job.

6. Master Dial:

- Increases (+) or decreases (-) the numeric value for the selected setting when turned. Navigates through the Job Selections.

7. Front Roller Press:

- When pressed, the Main Rollers will move to the Press or Down position.

8. Front Roller Release:

- When pressed, Top Main Roller will move to the Up or Release position.

9. Reset:

- When pressed, the counter will reset to “0”.

10. Rear Roller Press:

- When pressed, The Pull Roller or Rear Roller will move to the Press or Down position.

11. Rear Roller Release:

- When pressed, The Pull Roller or Rear Roller will move to the Release or Up position.

12. Cooling:

- When pressed, The Cooling Fans will Turn On. When pressed again, they will turn Off.

13. Start:

- When pressed, The Pull rollers or Rear Roller will move to the Press or Down Position.

14. Stop:

- When pressed, The Rollers will stop rotating.

15. Direction:

- When pressed, the direction of the machine can be changed. Forward and Reverse.

There are 2 Lamination Processes on 4064WF-1, LAM and ACCUSHIELD.

LAM:

This setting is intended to be used when an operator wants to use both the top and bottom heater, and wants full downward pressure on the Main Rolls.

To Select a Different Pressure or Gap:

Press **STOP** to stop the machine.

Press **JOB**.

Rotate the **MASTER DIAL**.

The Pressure and Gap selections are: LAM, 0", 1/16", 1/8", 3/16", 1/4", 3/8", 1/2", 3/4", 1"

FIGURE 1.

TOP:032°F	WAIT
BOT:032°F	SPD:07ft
POS:LAM	→FRONT→
DISTANCE: 00036ft	

FIGURE 1 shows:

Top and Bottom heat is set to 32*

Position of the Rollers are Set at the highest downward pressure.

The distance this machine ran since being reset is 36ft.

WAIT indicates the machine is out of the range of the set temp.

Speed is set for 7ft/mn

The direction of the laminator is set to go forward.

FIGURE 2.

TOP:220°F	READY
BOT:115°F	SPD:07ft
POS:LAM	→FRONT→
DISTANCE: 00036ft	

FIGURE 2 shows:

The Top Heat has been set to 220°F

The Bottom Heat has been set to 115°F

Position of the Rollers are Set at the highest downward pressure.

The distance this machine ran since being reset is 36ft.

READY Indicates that the temperature has reach the desired set-temp.

Speed is set for 7ft/mn

The direction of the laminator is set to go forward.

A-SHLD:

This setting is intended to be used when an operator wants to run ACCUSHIELD. This process requires the rollers to rotate as soon as the solenoids are activated.

ACCUSHIELD also requires that the lower roll NOT heat up. All the settings in A-SHLD will have:

The lower roll pre-set to 32°F

Rollers will rotate as soon as the rollers drop.

Rollers will rise before the rollers stop rotating.

To Select ACCUSHIELD Mode:

Press STOP.

Press JOB.

Rotate the Master Dial until LAM is shown.

Press and hold the JOB Button. (*The machine will “Beep” indicating that the machine is now in ACCUSHIELD Mode.*)

The LCD will Indicate ACCUSHIELD, and then display the Gap or Pressure.

To Select a Different Pressure or Gap:

Press STOP to stop the machine.

Press JOB.

Rotate the MASTER DIAL.

The Pressure and Gap selections are: LAM, 0”, 1/16”, 1/8”, 3/16”, 1/4”, 3/8”, 1/2”, 3/4”, 1”

FIGURE 3.

TOP:265°F	READY
BOT:032°F	SPD:03ft
POS:LAM	→FRONT→
DISTANCE: 00096ft	

FIGURE 3 shows:

The Top Heat has been set to 265°F

The Bottom Heat is pre-set to 032°F

Position of the Rollers are Set at the highest downward pressure.

The distance this machine ran since being reset is 96ft.

READY Indicates that the temperature has reach the desired set-temp.

Speed is set for 3ft/mn

The direction of the laminator is set to go forward.

Saving Temps and Speeds

The operator is able to save Temps and Speeds for certain processes on the 4064WF-1.

When operating the laminator in the lamination mode, the operator can save the Speed, Top Heat, & Bottom Heat.

For each Gap or Pressure setting, one job can be saved.

Ex: When the GAP is set on 0", the TOP & BOTTOM Heat can be saved, as well as the speed.

To Save the TOP Heat:

Press "TOP TEMP"

Rotate the Master Dial until the desired Temp is displayed.

Press and hold "TOP TEMP".

When the "TEMP" on the LCD stops Blinking, the Temp for this Setting is saved.

To Save the BOTTOM Heat:

Press "BOT TEMP"

Rotate the Master Dial until the desired Temp is displayed.

Press and hold "BOT TEMP".

When the "TEMP" on the LCD stops Blinking, the Temp for this Setting is saved.

To Save the Speed:

Press "SPEED".

Rotate the Master Dial until the desired Speed is displayed.

Press and hold "SPEED".

When SPEED stops blinking, the Speed is saved.

NOTE:

When operating the laminator in the ACCUSHIELD mode, the operator can only save the Speed, & Top Heat.

LCD QUICK REFERENCE SHEET

Figure 1

TOP: 265*F	WAIT
BOT: 032*F	SPD: 03ft
POS: LAM	→FRONT→
FRONT TENSION ERR!!!!	

FIGURE 1:

When jobs are changed, the shim dials will automatically rotate to the desired setting. Front Tension Error indicates that the Front Shim Dial has not located the desired setting.

- Make sure Air is applied to the machine.
- Re-set the Main Power.

Figure 2

TOP: 265*F	WAIT
BOT: 032*F	SPD: 03ft
POS: LAM	→FRONT→
FRONT TENSION SEARCHING!	

FIGURE 2:

When jobs are changed, the shim dials will automatically rotate to the desired setting. As the Front Shim Dials are locating the desired setting, the LCD will indicate this by displaying: FRONT TENSION SEARCHING.

- Wait for Shim Dial to locate the desired setting.

Figure 3

TOP: 265*F	WAIT
BOT: 032*F	SPD: 03ft
POS: LAM	→FRONT→
REAR TENSION ERR!!!!	

FIGURE 3:

When jobs are changed, the shim dials will automatically rotate to the desired setting. Rear Tension Error indicates that the Rear Shim Dial has not located the desired setting.

- Make sure Air is applied to the machine.
- Re-set the Main Power.

Figure 4

TOP: 265*F	WAIT
BOT: 032*F	SPD: 03ft
POS: LAM	→FRONT→
REAR TENSION SEARCHING!	

FIGURE 4:

When jobs are changed, the shim dials will automatically rotate to the desired setting. As the Rear Shim Dials are locating the desired setting, the LCD will indicate this by displaying: REAR TENSION SEARCHING.

- Wait for Shim Dial to locate the desired setting.

Figure 5

TOP: 265*F	WAIT
BOT: 032*F	SPD: 03ft
POS: LAM	→FRONT→
E-SWITCH PRESSED!!!	

FIGURE 5:

When an Emergency Stop is pressed, the LCD will indicate: E-SWITCH PRESSED!!

- Locate the Emergency Stop that is activated.
- Return the Emergency Switch to normal position.
- Now the Machine can be operated.

Figure 6

TOP: 265*F	WAIT
BOT: 032*F	SPD: 03ft
POS: LAM	→FRONT→
FR ACTIVATE SAFETY!!!	

FIGURE 6:

When a Safety Interlock is not correctly positioned, the LCD will read: ACTIVATE SAFETY!

- Locate the Safety Interlock that is not properly set.
- Now the Machine can be operated.

LCD DETAILED REFERENCE SHEET

FIGURE 1

TOP: 230°F	WAIT
BOT: 230°F	SPEED: 05ft
POS: ½"	<REAR<
DISTANCE: 00000ft.	

FIGURE 1:

- Top Temp is set for 230°F
- Bottom Temp is set for 230°F
- Position of Rollers or Job is ½ inch.
- Distance the machine ran is 00000ft.
- WAIT indicates that the heat has not reached the set point. *(To see the current actual temp, press and hold the Master Dial.)*
- REAR indicates that the unit is set to run in reverse mode.

FIGURE 2

TOP: 230°F	WAIT
BOT: 230°F	SPEED: 05ft
POS: ½"	<REAR<
E-SWITCH PRESSED!	

FIGURE 2:

- Top Temp is set for 230°F
- Bottom Temp is set for 230°F
- Position of Rollers or Job is ½ inch.
- E-SWITCH PRESSED! Indicates that there is an Emergency Stop pressed. The machine will not run until the E-Stop is released.
- WAIT indicates that the heat has not reached the set point. *(To see the current actual temp, press and hold the Master Dial.)*
- REAR indicates that the unit is set to run in reverse mode.

FIGURE 3

TOP: 230°F	WAIT
BOT: 230°F	SPEED: 05ft
POS: ½"	<REAR<
SEARCHING	

FIGURE 3:

- Top Temp is set for 230°F
- Bottom Temp is set for 230°F
- Position of Rollers or Job is ½ inch.
- SEARCHING indicates that the shim dials are searching for the correct location..
- WAIT indicates that the heat has not reached the set point. *(To see the current actual temp, press and hold the Master Dial.)*
- REAR indicates that the unit is set to run in reverse mode.

FEATURES/ACCESORIES GUIDE

Refer to the following pages for detailed information on the Features

FIGURE A



1. Emergency Stop Buttons: (FIGURE A, Item 1)

Four E-Stop buttons are on the Laminator located on the top of the Laminator at all four corners.

To Engage E-Stop buttons, press any E-Stop Safety Push button to stop the roller movement.

To disengage turn the push button clockwise when the emergency condition has been resolved.

FIGURE B

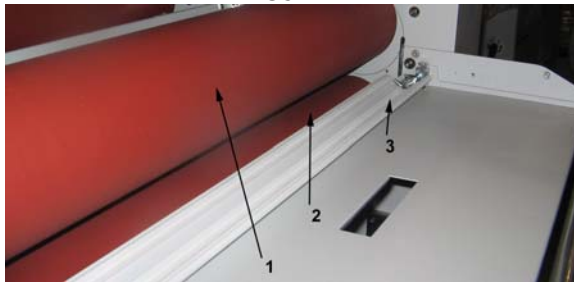

1. Heated Main Top Roller: (FIGURE B, Item 1)

Silicone rubber coated steel tube heat the laminating film and compress the heated film to the items being laminated. Heat is provided by an internal heating element.

2. Heated Main Bottom Roller: (FIGURE B, Item 2)

Silicone rubber coated steel tube heat the laminating film and compress the heated film to the items being laminated. Heat is provided by an internal heating element.

3. Media Pressure Plate: (FIGURE B, Item 3)

The Pressure Plate mounted to the front of the table helps hold down the image as it enters the Nip Area. To remove, move Spring Pin, and remove Pressure Plate.

FIGURE C



1. Front Table: (FIGURE C, Item 1)

The Front Table aids the operator when aligning media. The Front Table is stationary but pivots down for easy access to the film. To pivot the table down, lift up on the Media idler (FIGURE C, Item 2) and pull the table towards you. The table can now pivot down.

Note: The machine is limited to 3ft/min while either table is in the down position.

2 Table Idler: (FIGURE C, Item 2)

The Table Idler assists feeding of images into the web. It is helpful in roll to roll operation and helps move large rigid panels through the nip.

FIGURE D

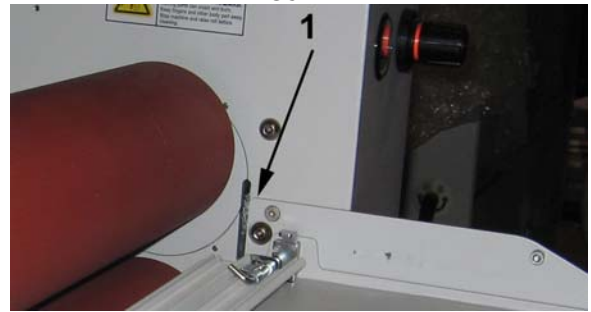

1. Safety Light Beam System: (FIGURE D, Item 1)

The 4064WF-1 uses a Safety Light Beam to protect the end-user from harm. When this Beam is blocked, the Rollers will stop rotating. Once the Beam is interrupted, the operator must re-start the machine by pressing Run. There are 2 sets of Safety Light Beams. One set in the front, one set in the rear. (See Sequence of Operation Chart for detail sequence of the Safety Beam. Diagram 1 Page 11)

FIGURE E

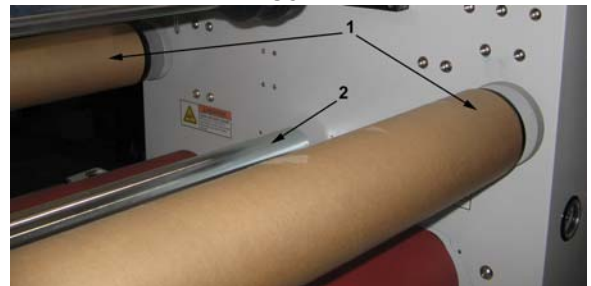

1. Rewinder Tubes: (FIGURE E, Item 1)

Used to rewind release liners or finished Medias.

2. Upper Tension Idler Bar: (FIGURE E, Item 2)

The Upper Tension Idler Guides the upper lamination onto the Top Main Roller insuring a constant amount of wrap on the Top Main Roller.

FIGURE F

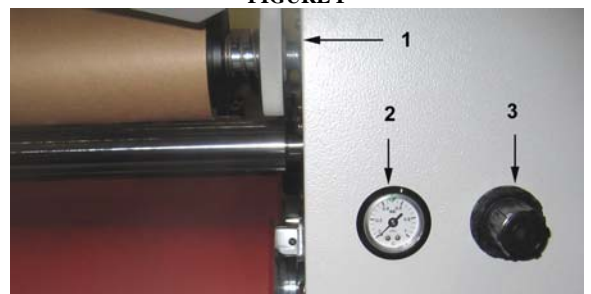

1. Rewinder Clutch Adjustment: (FIGURE F, Item 1)

The 4064WF-1 has Rewinder Tubes that will take-up release liners and rewind finished product. By rotating the gnarled disk (FIGURE F, Item 1) Counter Clockwise, the take up action will increase. Counter Clockwise will reduce the effect.

2. Nip Pressure: (FIGURE F, Item 2)

The 4064WF-1 uses pneumatics to operate the Main Rollers and Pull Rollers. You can adjust the amount of PSI that is desired on the Main Rollers and Pull Rolls by rotating the Pneumatic Adjustment Knob (FIGURE F, Item 3). To increase PSI, rotate the knob cock-wise. To reduce the amount of PSI, turn the knob counter clock-wise.

3. Pneumatic Adjustment Knob: (FIGURE F, Item 3)

To increase PSI, rotate the knob cock-wise. To reduce the amount of PSI, turn the knob counter clock-wise.

FIGURE G



1. Main Air Supply: (FIGURE G, Item 1)
The 4064WF-1 requires Compressed Air. Connect to the Main Air Supply at #1.

FIGURE H

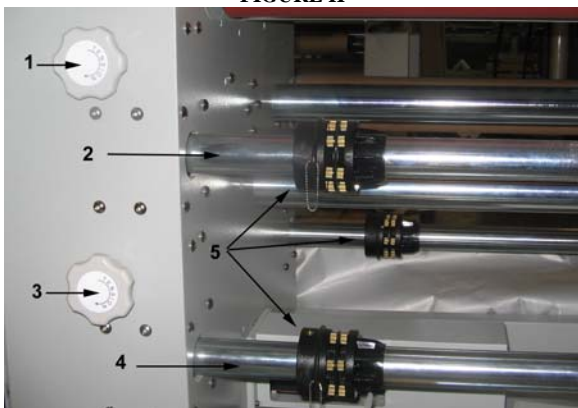

1 & 3. Swing -Out Film Unwind Shaft Brake Tension Knob: (FIGURE H, Item 1 & 3)

The Swing-out Film Shaft is used to provide tension to match materials going into the laminated rollers. To increase tension, rotate the knob clock-wise. To reduce tension, rotate the knob counter clock-wise

2 & 4. Swing -Out Film Unwind Shaft: (FIGURE H, Item 2 & 4)

The Swing-out Film Shaft is used to provide tension to match material when holding media and materials.

5. Core Chucks: (FIGURE H, Item 5)

Bi-Directional Core Chucks grip the Medias supply tube. Our patented roller core chuck will allow the operator the ability to add or remove film with ease.

FIGURE I



1. Upper Pull Roll: (FIGURE I, Item 1)
The Pull rollers located at the back of the laminator are motor driven. They simultaneously pull the film and image. The Upper Pull Roller (FIGURE I, Item 1) can be Raised and Lowered via the Main Control Panel.

2. Lower Pull Roll: (FIGURE I, Item 2)

The Pull rollers located at the back of the laminator are motor driven. They simultaneously pull the film and image. The Lower Pull Roller is clutched.

3. Rear Table: (FIGURE I, Item 3)

Used to support finished Media and used when running the machine from the rear.

4. Rear Table Safety Interlock Switch: (FIGURE I, Item 4)

The Rear Table Safety Switch ensures that the Rear Table is inserted properly and if not engaged, the machine will only operate with the foot switch at 3ft/mn.

FIGURE J



1. Rear Slitter: (FIGURE J, Item 1)

The Rear Slitter is used for slitting Media after lamination. Press down on the Slitter Assy' (FIGURE J, Item 1) to engage the slitter.

2. Rear Slitter Track Assy': (FIGURE J, Item 2)

The Rear Slitter Track Assy' allows the Slitter Assy' to travel the length of the Rear Table.

3. Rear Table Media Idler: (FIGURE J, Item 3)

Used for guiding Media through the laminator. The table Idler is helpful in roll to roll operation and helps move large ridged panels through the nip.

FIGURE K

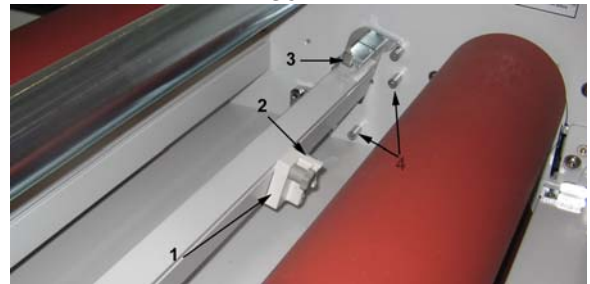

1. In-Line Slitters: (FIGURE K, Item 1)

The In-Line Slitters allows the operator to slit images as they pass through the Main Rollers and into the Pull rollers. The trimmed waste can then be attached to the Rewinder Tubes and disposed of later.

2. Slitter Blade Switch: (FIGURE K, Item 2)

The Slitter Blade can be engaged by pressing down carefully on the Blade Switch. To disengage, carefully pull up on the Slitter Blade Switch.

3. In-Line Slitter Bar Mounting Lever: (FIGURE K, Item 3)

The In-Line Slitters bar mounting Lever Allows the operator to remove the Slitter Bar Assy' or position it to the desired location.

4. In-Line Slitters Cutting Position: (FIGURE K, Item 4)

To lower the position of the In-Line Slitter Bar, release the Lever and relocate to the position shown in FIGURE K Item 4.

FIGURE L

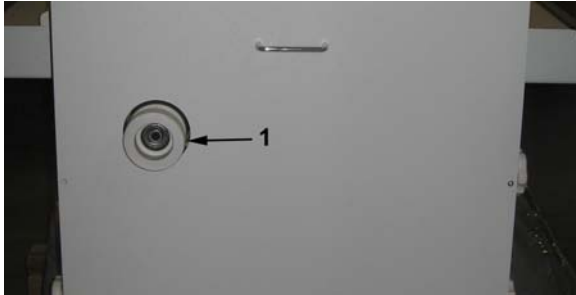

1. Pull Roll Clutch: (FIGURE L Item 1)

The Pull Roll Clutch provides tension on the laminated film between the main rolls and pull rolls as the material is cooling.

FIGURE M

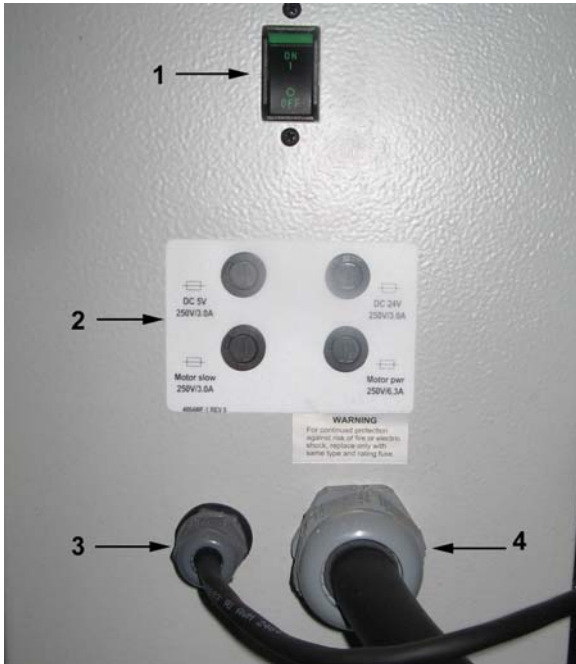

1. Main Circuit Breaker/ ON/OFF Switch: (FIGURE M Item 1)

To apply Main Power to the Laminator, Press the switch to the “ON” Position. To disconnect Main Power to the Laminator, press the switch to the “OFF” position.

2. Fuses: (FIGURE M Item 2)

There are 4 fuses. Each one is labeled to describe each fuses function.

3. Foot Switch Cord: (FIGURE M Item 3)

The Foot Switch is attached to the Footswitch cord.

4. Main Power Cord: (FIGURE M Item 4)

The main Power Cord is used to supply Main voltage to the Laminator.

FIGURE N

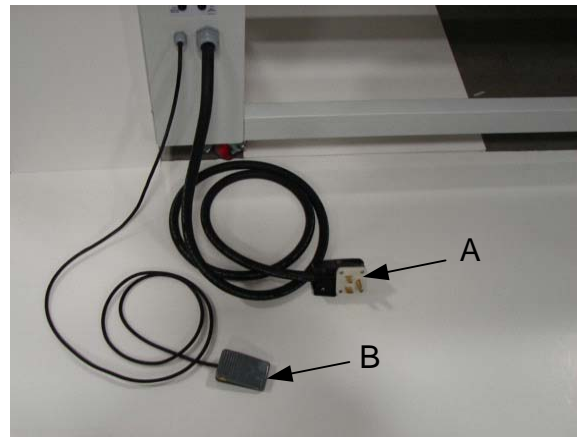

1. Main Power Cord. (FIGURE N Item A)

The Main Power Cord Plugs into the Main Power Supply. See Power Requirements in the Specs part of the manual for required Voltage and Amperage.

2. Foot Switch. (FIGURE N Item B)

The Foot Switch allows the operator to run the machine hands free. When the PICO System is not blocked, the Foot Switch will activate the Main Rollers, and the machine will run at the set speed on the Main Control Panel. The Speed can be adjusted by selecting the Speed button and using the Main Dial to increase or decrease speed while unit is running.

SEQUENCE OF OPERATIONS

Diagram #1

GBC U.S 4064WF-1

Effect of Fiber Optics on sequence of operation

Modes	Situation 1	Situation 2	Situation 3
<u>Machine Run Mode</u>	<p>Normal operation (No Interruption to any safety circuitry & Fiber optic beam)</p> <p>High speed.</p>	<p>Interrupted fiber optic beam or opened any safety circuitry.</p>	<p>Fiber optic beam cleared + all safety circuitries are closed</p>
<p><u>Forward Mode</u> Press push button forward switch</p>	<p>Control panel: Forward Speed: Zero to Max. Press "Run" push button to switch over from foot switch to the control panel.</p>	<p>Machine stops Instantly. Use foot pedal to override @ 3f/m.</p>	<p>Machine will remain stationary until run switch is pressed. Push RUN button switch to run machine again (Normal operation) mode.</p>
	<p>Foot switch: Forward Speed: Zero to Max. Note: Press foot pedal to change mode and take over from control panel at preset speed.</p>	<p>Machine Runs @ 3f/m. (Automatic override from high to low voltage)</p>	<p>Machine still remains at low voltage speed of 3f/m. Steps required to run at (various speed): The operator will have two choices,</p> <p>Choice A: 1. Release foot pedal to stop machine. 2. Press foot pedal again to start machine at original preset control panel knob speed (pot).</p> <p>Choice B: 1. Press and hold "Run" push button switch on the control panel while foot is still on pedal. 2. Release foot pedal. 3. Adjust speed using "speed knob"</p>
<p><u>Reverse Mode</u> Press Reverse Push button switch.</p>	<p>Reverse speed: Zero to Max. Press "Run" push button to switch over from Foot switch to the Control panel.</p>	<p>Machine stops Instantly. Use Foot pedal to override @ 3f/m.</p>	<p>Machine must not run. It will remain stationary. Push RUN button switch to run machine again at Normal operation mode.</p>
	<p>Reverse speed: Zero to Max. Note: Press foot pedal to change mode and take over from control panel.</p>	<p>Machine Runs @ 3f/m. (Automatic override from high to low voltage)</p>	<p>Machine still remains at low voltage speed of 3f/m. Steps required to run at (various speed): The operator will have two choices,</p> <p>Choice A: 1. Release foot pedal to stop machine. 2. Press foot pedal again to start machine at original preset control panel knob speed (pot).</p> <p>Choice B: 1. Press and hold "Run" push button switch on the control panel while foot is still on pedal. 2. Release foot pedal. 3. Adjust speed using "speed knob"</p>

OPERATING INSTRUCTIONS

Film Loading & Threading

The top and bottom rolls of laminating film must be of the same width and be present simultaneously. A Small amount of adhesive will “squeeze out” during Lamination. Hardened adhesive deposits can damage the heat rollers.

CAUTION:

Adhesive will deposit on the rollers if:

- Only one roll is used.
- Different widths of rolls are loaded together.
- Either roll is loaded adhesive side against a heat roller.
- One or both rolls of film are allowed to run completely off its core.

The adhesive side of the film is on the inner side of the web (Fig. 17A & B). The shiny side of clear film must contact the heat rollers. The dull side of the film contains the adhesive. Use extreme caution when loading delustered (matte) film as both sides appear dull.

Always change the top and bottom supply rolls at the same time. Near the end of each roll of GBC laminating film is a label stating “Warning-End of Roll”. The appearance of this label on either the top or bottom roll requires that new rolls of film be installed as soon as the item presently being laminated completely exits the rear of the laminator.

Do not introduce any additional items into the laminator when the warning label is visible.

To load a roll of film: (Fig. 18)

1. Pull the swing out shaft clevis pin up.
2. Swing shaft outward.
3. Slide the roll of film onto the film shaft ensuring Adhesive side is out.
4. Push the film shaft back into the film shaft Support saddle.
5. Push the clevis pin down.
6. Center the roll of film.

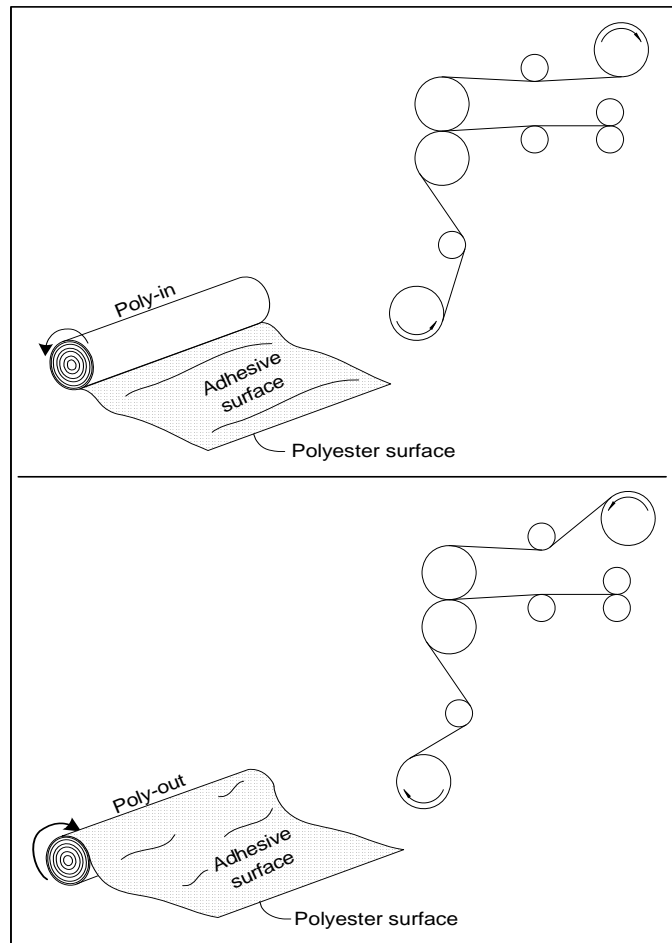

FIGURE 17

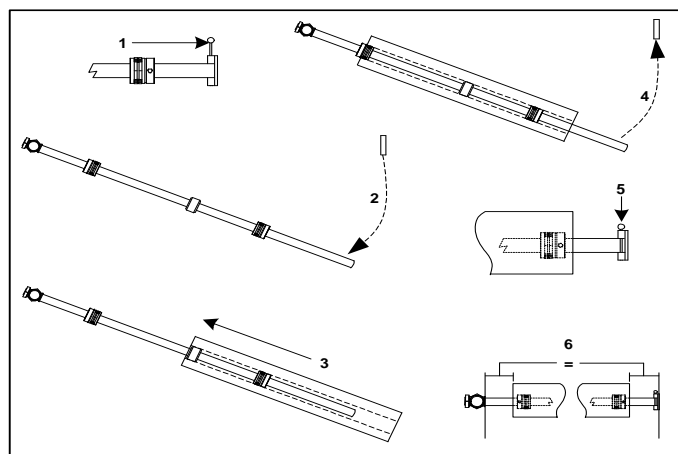





FIGURE 18

Webbing Thermal Film Using Threading Card



CAUTION: The laminator rollers will be hot and can burn you. For pressure sensitive film (PSA), refer to the section titled

WEBBING: USING FILM THREADING CARD FOR PSA FILM.

1. Turn the Main Power ON  /OFF  to On. 
2. Set top and bottom temperature with regards to the film type used.
3. Ensure no brake tension is applied to the film shafts.
4. Pull the top roll film down under the upper idler bar and allow to drape over the top heat roller (Fig. 19)
5. Pull the lower film behind the lower idler bar, Lower the table Pull Film up towards the film draped over the top heat roller and adhere the Lower Film to the upper Film (Fig. 20).
6. Pivot the table back to its feeding position while ensuring the threading card is on top of the feed table (Fig. 21).
7. Use a threading card to push the two materials into the heat roller nip.
8. Lower the main roller to initial contact with the threading card.
9. Ensure forward is selected for Motor direction and Press the Foot Switch
10. From the rear of the machine, guide the web over the chill idler, if installed, and through the pull rollers.
11. Once the web has entered the pull roller nip, lower the pull roller nip. Adjust unwind film tension; use as little tension as possible to get smooth output.
12. Once the threading card has completely exited the pull rollers, press the stop () button.
13. Now refer to the section entitled START LAMINATING.

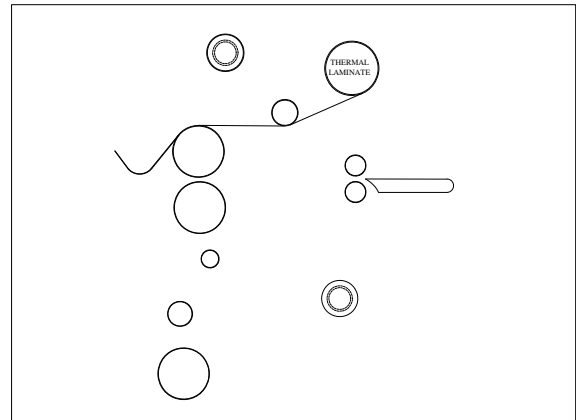

FIGURE 19

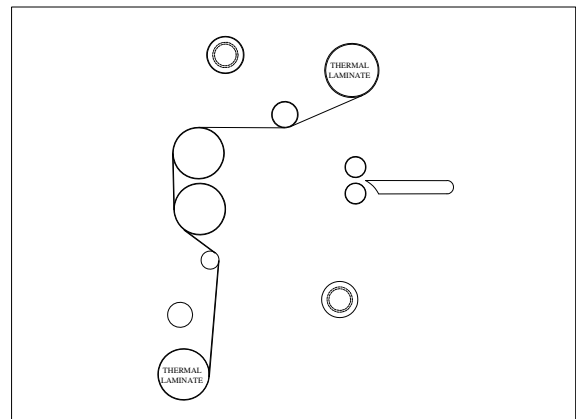

FIGURE 20

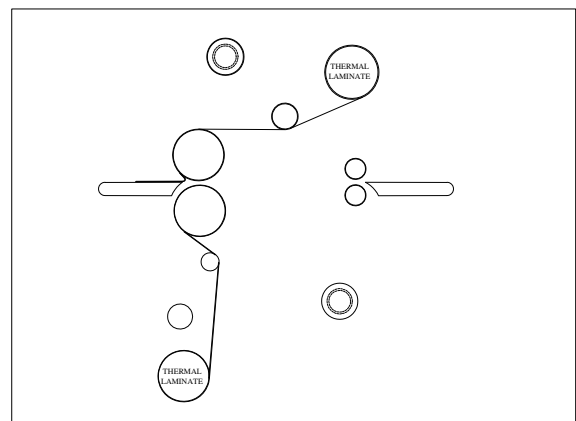

FIGURE 21

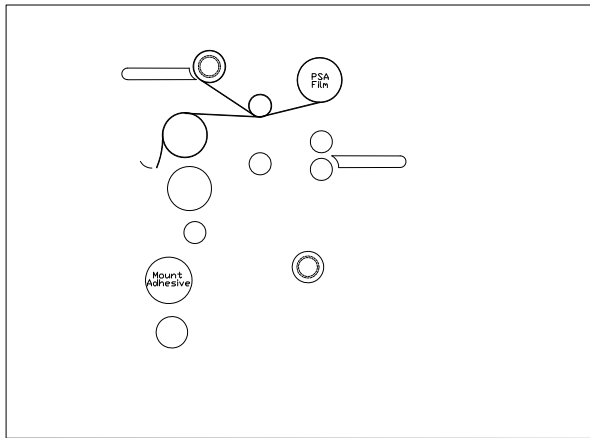

FIGURE 22

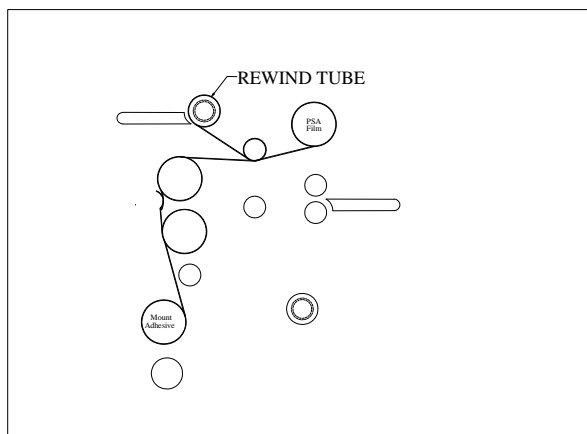

FIGURE 23

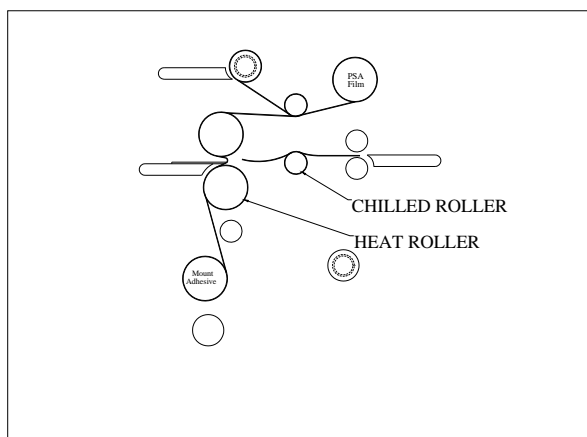





FIGURE 24

Webbing PSA Film/Mount Adhesive Using Threading Card

The laminator should be cool to the touch before Proceeding.

1. Turn the Power ON  /OFF  to On 
2. Load the rolls of film as illustrated in (Fig. 22). Ensure no brake tension is applied to the film shafts.
3. Pull the top roll of film down under the idler bar and up to the upper front rewind tube.
4. Place one piece of masking tape in the center of the film and secure to the rewind tube.
5. Make two full wraps around the rewind tube, and then score the laminate without cutting the release liner. Pull the laminate down allowing it to drape over the upper roller (Fig. 22).
6. Pull the mount adhesive up towards the film draped over the upper heat roller (Fig. 23).
7. Stick the mount adhesive to the exposed adhesive of the upper roll.
8. Insert the table back to its feeding position while ensuring the threading card is on top of the feed table (Fig. 24).
9. Use a threading card to push the two materials through the heat roller nip
10. Lower the main heated roller to bring the main roller into initial contact with the threading card. Ensure front is selected and press the foot switch.
11. From the rear of the machine, guide the web over the chill idler, if installed, and through the pull rollers. Once the web has entered the pull roller nip, close the pull roller nip –
12. Press the stop () button when the threading card has completely exited the pull rollers and adjusts the film web tension using as little tension as possible.
13. Now refer to the section titled START LAMINATING.

Start Laminating

1. At this point you should have your laminator webbed with the appropriate material for your application.
2. The feed table should be in the normal operating position.
3. Close the main and Pull roll nips. Rollers should be closed.
4. Speed is set to 3 or less and front () motor direction is selected.
5. Press the start (◊) button.
6. Set main roller pressure between 40% – 60% for laminating by turning the main roll lift handle.

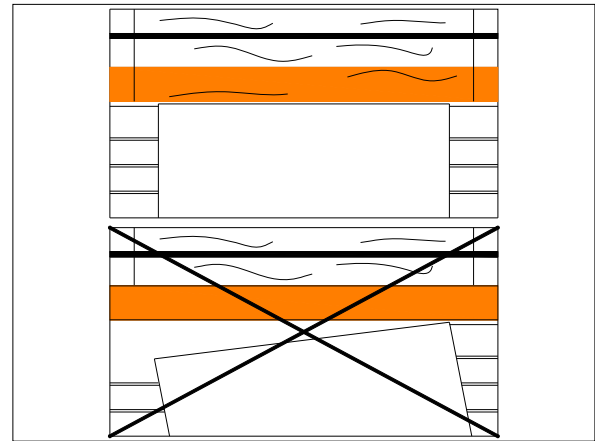

FIGURE 25

CAUTION: If using PSA film, an air pocket may form between the main rollers and pull rollers. Raise the pull rollers to allow the air Pocket to pass.

7. Make any necessary film brake tension adjustments, pull/main roller pressure, and clutch and/ or rewind brake tension adjustments.
8. Position the item to be laminated on the feed table.
9. Align the leading edge of the item parallel to the heat roller nip (Fig. 25).
10. Use both hands to force the image outward and slowly push inward toward the nip of the heat rollers (Fig. 26).

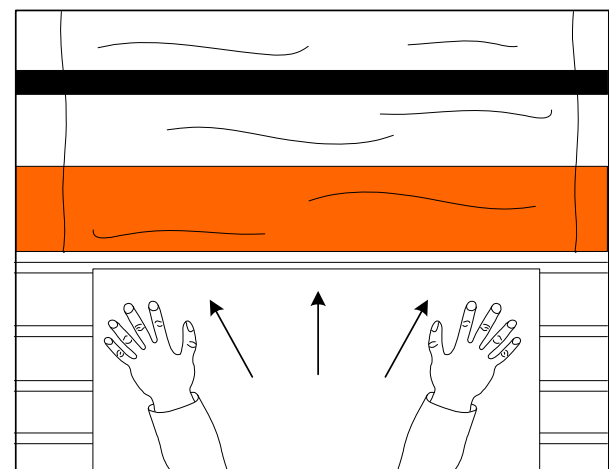

FIGURE 26

CAUTION: Avoid forcing the image into the main roller nip as this action will cause the corners of the leading edge to buckle and create a wave.

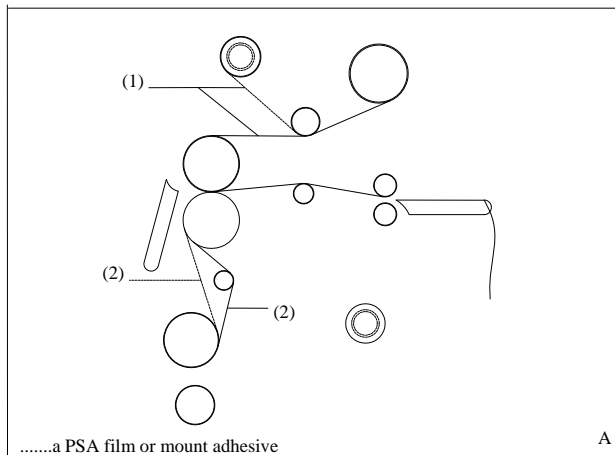

FIGURE 27

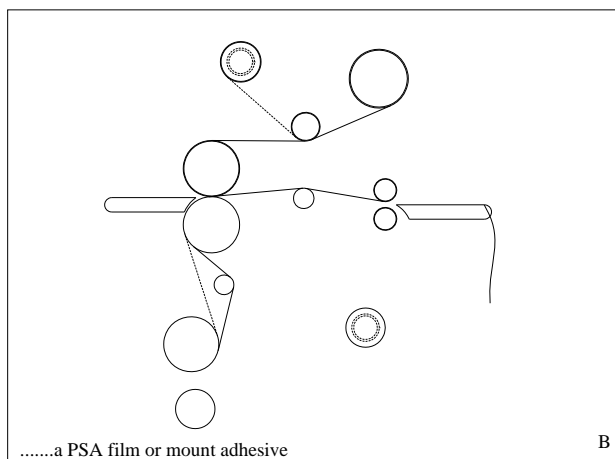

FIGURE 28

Method for Tacking New Film to Existing Film

The following describes a method for loading film whereby the existing film present on the heat rollers may be used in place of the threading card to draw the new film through the laminator. The adhesive of the existing film must be tacky or liquefied. Leading edges of the new film will be overlapped onto the tacky adhesive of the old film. The existing film and the new film will be pulled through the laminator together.



CAUTION: Do not cut yourself

CAUTION: Be careful not to cut any of the rollers!

1. Cut (1) remaining top film web between the idler bar and heat roller. Cut (2) the film web between the lower film supply and the idler bar (FIGURE 27).

CAUTION: Be careful not to cut any of the rollers!

2. Remove the feed table.
3. Do not allow the adhesive side of the film to contact the heat or pull rollers. Liquefied or tacky adhesive deposited on heat rollers will require the rollers to be cleaned per the section titled.
4. Replace both the top and bottom rolls of film with new rolls. Ensure the adhesive side is facing out.
5. Pull the film around the idler bars, with the exception of PSA mounting adhesives without a release liner.
6. Tack the new film to the existing film on the heat rollers. For PSA film, attach the release liner to the rewind tube
7. Use the footswitch to advance the film into the heat roller nip.
8. Observe the film being pulled through the laminator to assure that the remaining existing film and the new films are advancing concurrently. Any separation between the films will require stopping the motor immediately and the situation corrected.
9. Press STOP (⏹) once the newly threaded film has completely exited the pull rollers.

To unweb the laminator

Unweb the laminator if you are changing film widths, cleaning the rollers or have finished using the machine for the day.

**CAUTION: Do not cut yourself**

1. Using a slitter, cut (1) the output from the web (Fig. 29).
2. Cut (2) remaining top film web between the idler bar and heat roller. PSA film cut the release liner too.
3. Cut (3) the film web between the lower film supply and the idler bar (Fig. 29).

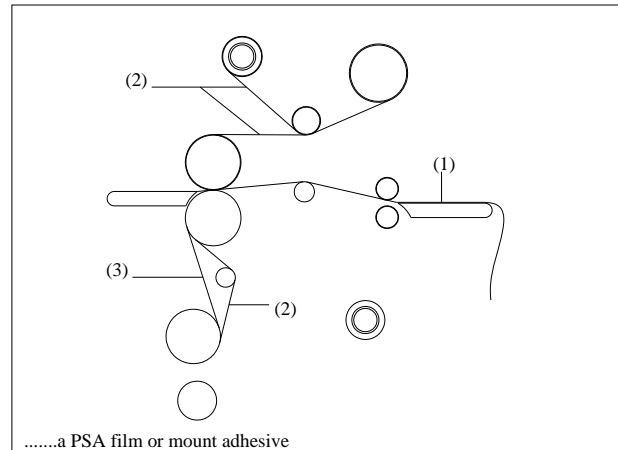
**FIGURE 29****CAUTION: Be careful not to cut any of the rollers!**

4. Remove the feed table.
5. Gap the main rollers and pull rollers.
6. Carefully grab hold of the web (top and bottom film), from the front operating position and pull towards you (Fig. 30).
7. Do not allow the adhesive side of the film to contact the heat or pull rollers.

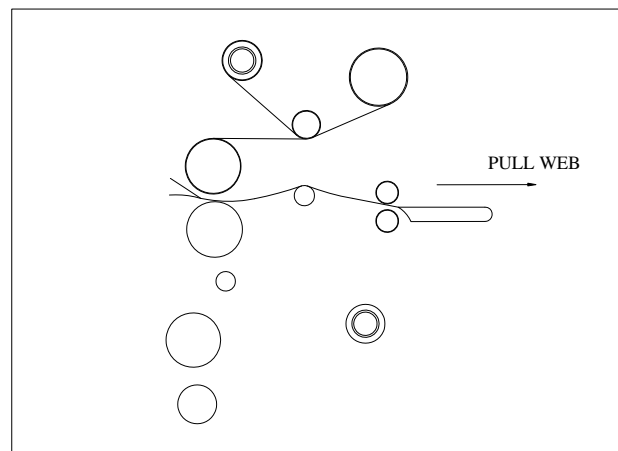
**FIGURE 30****Clearing a Film Jam (Wrap-up)**

Film jams (wrap-ups) may occur if the film is loaded backwards or if the area at which film exits the equipment is blocked. The film, when jammed, wraps around the heat rollers or pulls rollers during webbing.

To clear a jam:

1. Immediately stop the laminator by pressing STOP (⏹).
2. Set motor direction to rear.
3. Use the footswitch to reverse the web until the wrap up is clear.
4. Raise the main roller and pull rollers.
5. Manually guide the web from the main rollers and pull rollers.
6. Once the film jam has been cleared, lower the main roller and pull rollers.
7. Refer to the section titled START LAMINATING.

APPLICATIONS

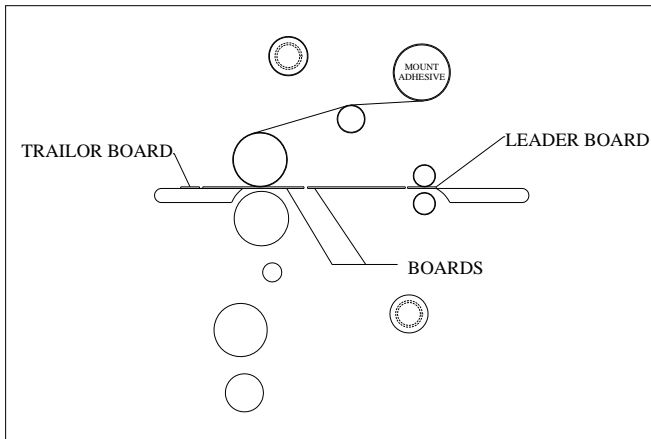

FIGURE 31

Tips for Pre Coating Boards

1. Load the laminator as illustrated in (Fig. 31). Remove chill idler.
2. The width of the roll should not exceed the width of the board by more than 1/2 in. (1.3 cm).
3. Use a leader board to set the main roller and pull roller pressure prior to webbing.
4. Use a leader board to start the run and a trailer board to finish the run.
5. Using the pull rollers will allow you to leave gaps between boards.
6. If not using the pull rollers, have the boards nearby to butt end to end during feeding.

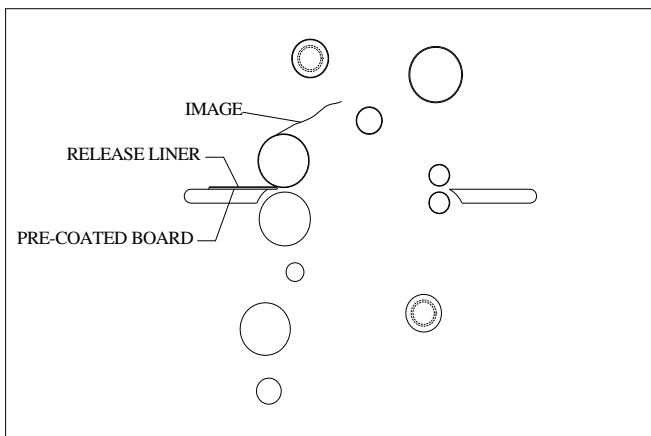

FIGURE 32

Tips for Mounting Pre Coated Boards

1. Use a leader board to set the main roller pressure prior to mounting the image.
2. Ensure the chill idler is removed and the rear slitter is to one side.
3. Do not stop once you have started the mounting process through the machine. (Fig. 32)

Note: This application can also be performed from the rear operating position. Reference Fig. 35 for Illustration.

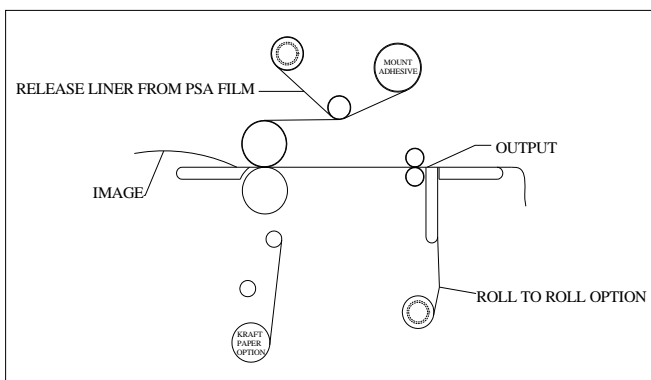

FIGURE 33

Tips for Single Sided lamination

1. Load the laminator as illustrated in Fig. 33.
2. Use kraft paper for one-sided lamination When ever the items to be laminated are narrower than the film you are using.
3. If not using kraft paper, use a scrap piece to finish the run or you will have adhesive on your rollers.
4. For high volume runs, use Kraft paper and the lower rear rewind for roll to roll operation.
5. Running the web over the chill idler may improve the Flatness of the output.
6. A little heat, 125 degree F (52 degree C), may help eliminate silvering effects associated with PSA films.

Tips for Creating a Decal

1. Load the laminator as illustrated in Fig. 34.
2. The over laminate may be PSA or thermal type.
3. If using thermal type, pay attention to the Poly-in/Poly-out rule.
4. Run a test material prior to running the actual image to ensure flat output.
5. Use minimal brake tension to achieve quality output.
6. Do not web the PSA mount adhesive around the lower web idler.

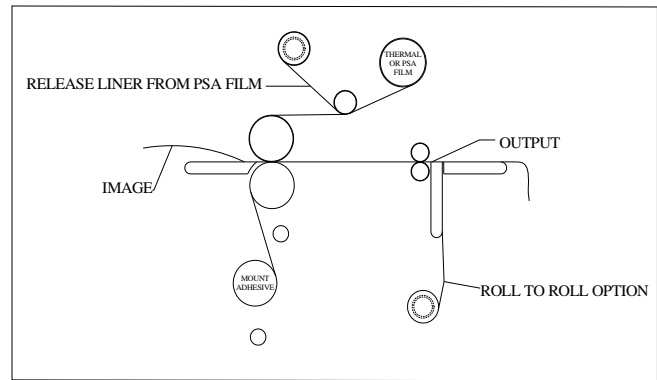
**FIGURE 34****Tips for mounting a Decal**

1. Use a leader board to set the pull roller pressure Prior to mounting the image.
2. The image should not exceed the width of the board by more than 1 in. (2.54 cm) per side.
3. Tack about 1 in. (2.54 cm) of the leading edge of the decal to the leading edge of the board.
4. When tacking the leading edge, start in the center and work to the sides.
5. Use a board that exceeds the size of the decal if inexperienced in the mounting application.

Note: This application can also be performed from the front operating position. Reference Fig. 31 for Illustration.

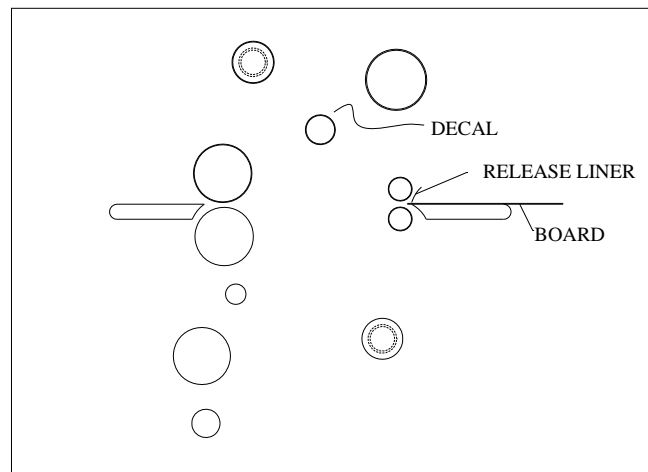
**FIGURE 35****Tips for Thermal Encapsulation**

1. Load the laminator as illustrated in Fig. 36 Poly-in film is used for illustration purpose.
2. Refer to section entitled FILM LOADING & THREADING for Poly-out film.
3. Always use two rolls of film the same width.
4. Use minimal brake tension to achieve flat output.
5. Increase speed gradually to maintain the activating temperature required for the laminate you are using.
6. Length and width of image, ink coverage and paper type may affect the temperature and speed recommended in the SPEED/ TEMPERATURE GUIDE.

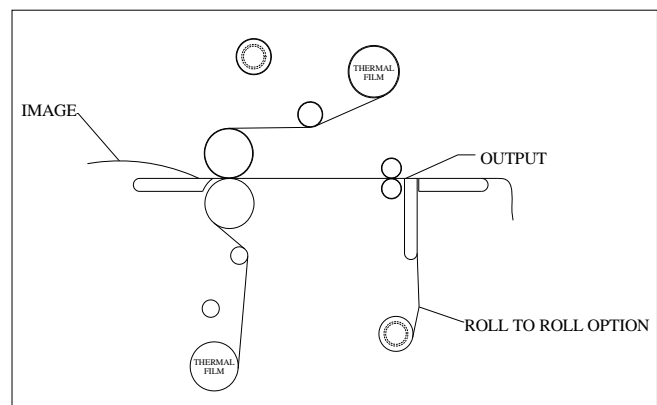
**FIGURE 36**

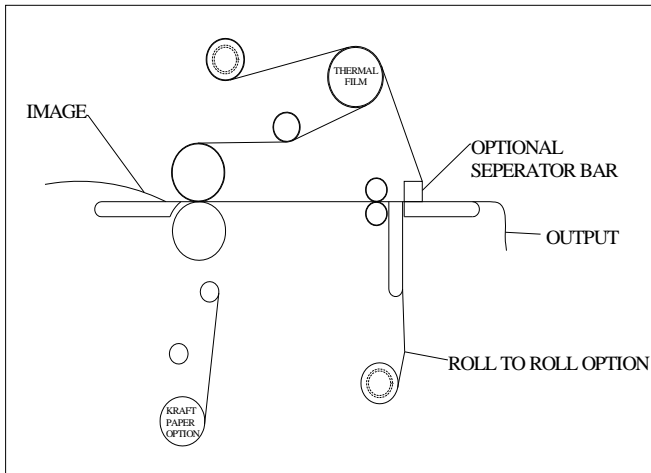

FIGURE 37

Tips for AccuShield

1. Load the laminator as illustrated in Fig. 37.
2. You must have the Separator bar option to accurately run this material. See your Sales Rep for ordering the Separator Bar.
3. Set Top Temp to 280* F(135* C) and a speed setting no greater than 4.
4. Liner rewind tension will be greater than normal operating standard
5. To prevent some adhesive adhering to the rollers, you may choose to use a roll of craft paper for a Carrier.

Use the blank space below and blank diagrams to Note your tips and web paths for your Special applications.

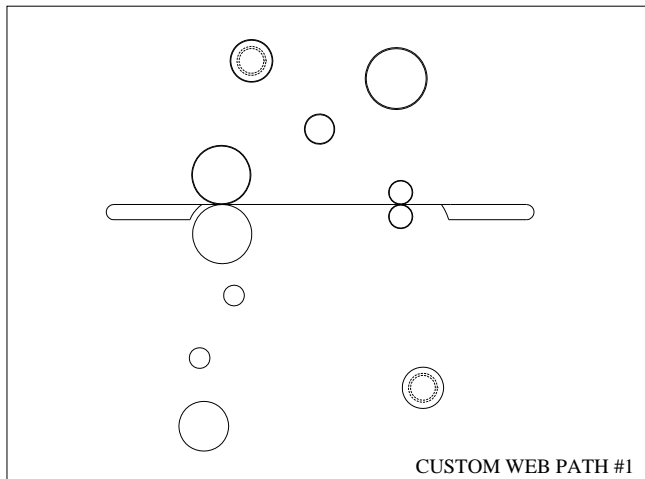

FIGURE 38

TIPS FOR CUSTOM APPLICATION #1 (Fig. 38)

- 1.
- 2.
- 3.
- 4.

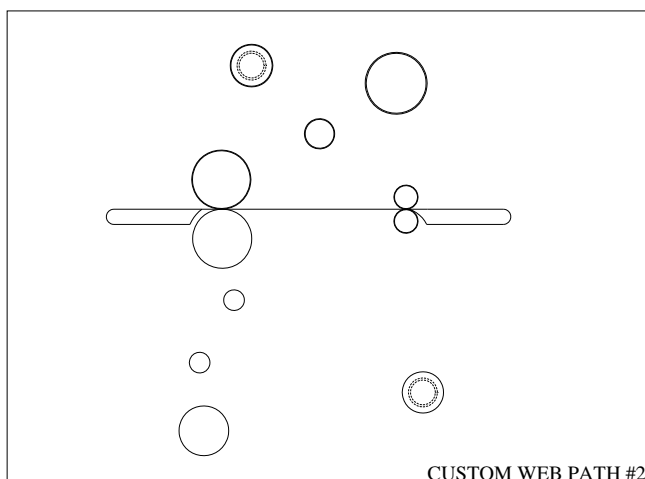

FIGURE 39

TIPS FOR CUSTOM APPLICATION #2 (Fig. 39)

- 1.
- 2.
- 3.
- 4.
- 5.

Orca 4064WF

Two-sided Pressure Sensitive Lamination - Front

Description: This process is used to apply a PSA laminate to both sides of a graphic. Most of the time, the top film will be a certain desired finish like gloss, lustre matte, etc..., while the film on the back of the graphic will be a light barrier laminate. Use this guide to help with the webbing of this process on the mentioned laminator.

Applications this process can create: Trade show graphics

Materials that can be used with this process: All Arctic Laminates.

Procedure

Step 1: Load roll of PSA laminate on top unwind and roll of PSA laminate on bottom unwind.
Step 2: Lower or remove any tables. The rollers should be in the up position.
Step 3: Pull top laminate under the idler toward the front of the laminator and attach it to the rewind. Rotate rewind one revolution to wrap film around it.
Step 4: Using a sharp blade, score the laminate to separate it from the release liner.
Step 5: Drape the laminate across the top main roller.
Step 6: Pull the bottom laminate around the idlers and up toward the main rollers. Attach the two materials together.
Step 7: Separate the release liner from the bottom PSA Laminate and attach it to the bottom rewind.
Step 8: Insert or raise the table on the laminator.
Step 9: Insert a leader board into the roller gap and lower the rollers down to the thickness of the leader board. Press start.
Step 10: Continue the leader board through the laminator until it exits the main rollers. Lower the rollers to the lamination setting. Adjust film tensions as needed. Check output for quality. Press stop.
Step 11: Press start and proceed with laminating graphics.

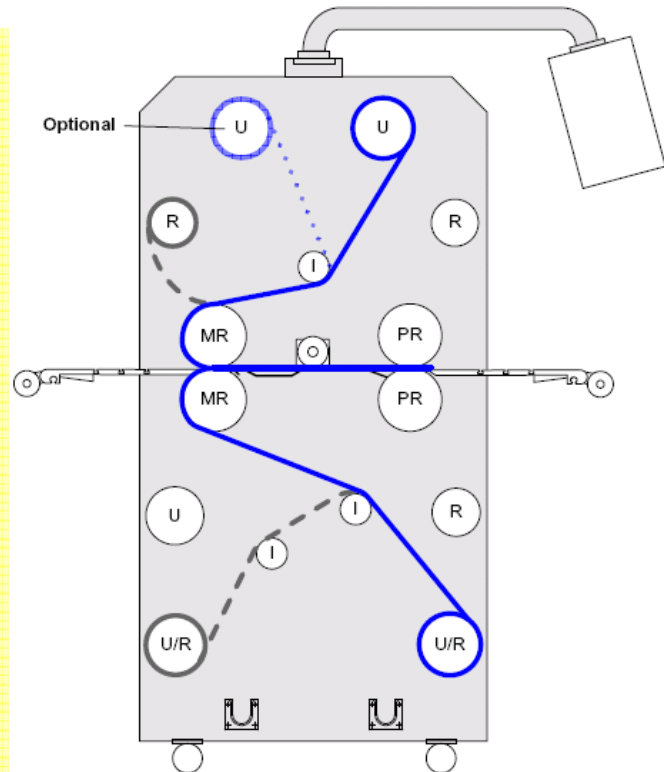
**Hints:**

- Use only one piece of tape in the middle when attaching the laminate to the rewind. This will allow the material to shift if necessary and make it easier to remove the liner later.
- When webbing the top and bottom laminate, make sure the edges of the laminate line up from the unwind to rewind to laminating roller. This will ensure the material is feeding straight.
- If the laminate starts to follow the release liner toward the rewind, either reduce tension on the rewind or increase tension on the unwind. If the release liner follows the laminate into the laminating rollers, increase tension on the rewind.
- The use of the pull rollers is optional. Using them will help pull the material out the back of the laminator. Reduce the clutch tension if using them. This will prevent stretching of the laminate and help reduce curl.

Orca 4064WF

One-sided Pressure Sensitive Lamination - Kraft - Front

Description: This process is used to apply a PSA film onto one side of a graphic using the Kraft paper method. Use this guide to help with the webbing of this process on the mentioned laminator/s.

Applications this process can create: Banners, Floor Graphics, Window Graphics, Countertop Graphics, Vehicle Graphics, Cooler Signage, Backlit Signage, and many more...

Materials that can be used with this process: All Arctic Laminates.

Procedure

Step 1: Load roll of PSA laminate on top unwind and roll of Kraft paper on bottom unwind.
Step 2: Lower or remove any tables. The rollers should be in the up position.
Step 3: Pull laminate under the idler toward the front of the laminator and attach it to the rewind. Rotate rewind one revolution to wrap film around it.
Step 4: Using a sharp blade, score the laminate to separate it from the release liner.
Step 5: Drape the laminate across the top main roller.
Step 6: Pull the Kraft paper around the idler and up toward the main rollers. Attach the two materials together.
Step 7: Raise or replace the tables on the laminator.
Step 8: Insert a leader board into the roller gap and lower the rollers down to the thickness of the leader board. Press start.
Step 9: After leader board exits the laminating rollers, lower the rollers to the laminating setting. Adjust film tensions as needed. Check output for quality. Press stop.
Step 10: Press start and proceed with laminating graphics.

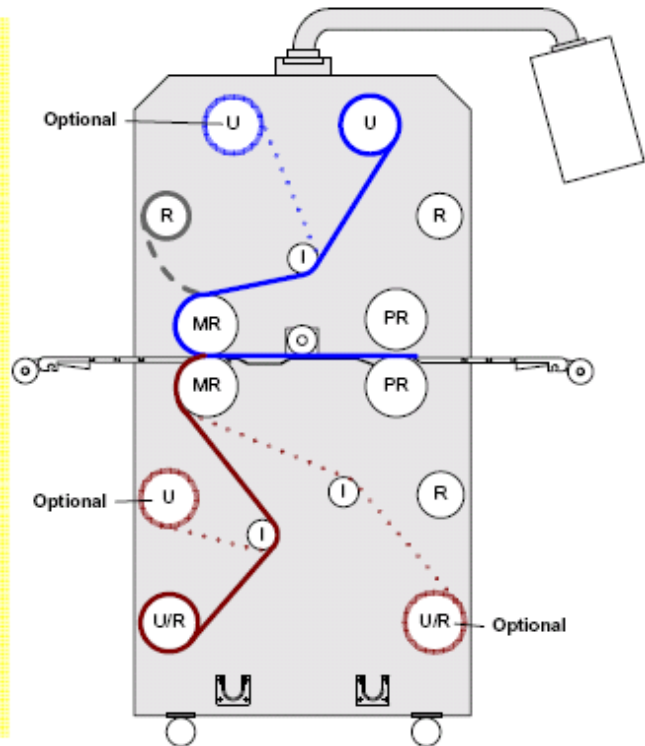

Hints:

- Use only one piece of tape in the middle when attaching the laminate to the rewind. This will allow the material to shift if necessary and make it easier to remove the liner later.
- When webbing the top laminate, make sure the edges of the laminate line up from the unwind to rewind to laminating roller. This will ensure the material is feeding straight.
- If the laminate starts to follow the release liner toward the rewind, either reduce tension on the rewind or increase tension on the unwind. If the release liner follows the laminate into the laminating rollers, increase tension on the rewind.
- The use of the pull rollers is optional. Using them will help pull the material out the back of the laminator. Reduce the clutch tension if using them. This will prevent stretching of the laminate and help reduce curl.

Orca 4064WF

Two-sided Thermal Lamination

Description: This process is used to apply a thermal laminate on the front and back of a graphic. Thermal laminates require heat, pressure and tension to produce optimal results. Speed should be monitored to maintain activation and sufficient cooling. The main rollers will need to be heated to required temperature of the particular laminate being used. Low melt adhesives will typically activate between 185 - 210 degrees F. Standard thermal laminates will typically activate between 210 – 270 degrees F.

Applications this process can create: Trade show graphics, Menus, Posters, Display Roll-ups, Maps, and many more...

Materials that can be used with this process: Octiva and Octiva Lo-Melt laminates

Procedure

Step 1: Load roll of thermal laminate on top unwind and roll of thermal laminate on bottom unwind.

Step 2: Lower or remove any tables. The rollers should be in the up position.

Step 3: Pull top laminate under the idler toward the front of the laminator and drape it over the main (heated) roller.

Step 4: Pull the bottom laminate around the idlers and up toward the main rollers. Attach the two materials together.

Step 5: Insert or raise the table on the laminator.

Step 6: Insert a leader board into the roller gap and lower the rollers down to the thickness of the leader board. Press start.

Step 7: Continue the leader board through the laminator until it exits the main rollers. Lower the rollers to the lamination setting.

Step 8: Continue leader board through the pull rollers. Lower pull rollers to the lamination setting.

Step 9: Adjust film tensions as needed. Check output for quality. Press stop.

Step 10: Press start and proceed with laminating graphics.

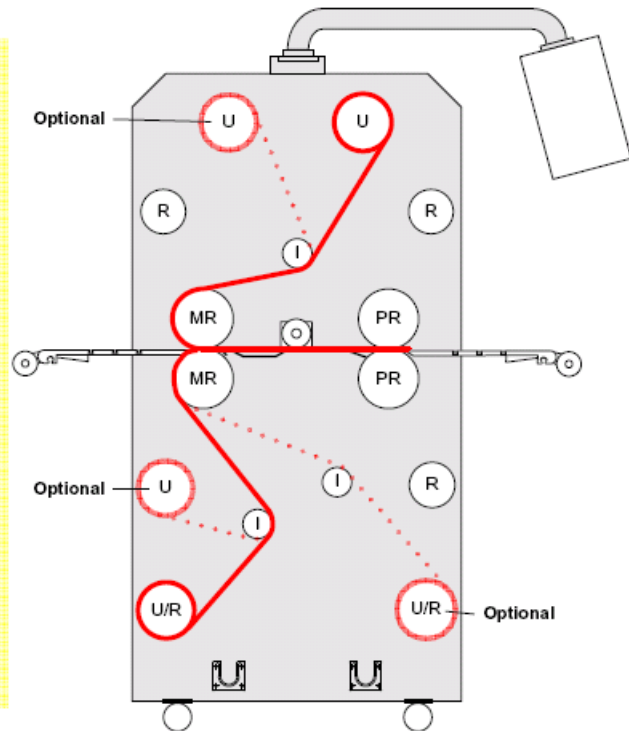
**Hints:**

- Thermal films work using four basic parameters: temperature, speed, pressure and tension. Each setting must be properly adjusted for optimal output.
- Chill idlers and cooling fans are used between the main and pull rollers to help iron out the films and provide quick cooling of the film.
- If your final output is curling up - either decrease the film tension on top or increase the bottom film tension. If your final output is curling down - either decrease the film tension on the bottom or increase the top film tension.
- Be sure to set the laminator speed to allow adequate thermal adhesive activation and proper cooling of the films before exiting the pull rollers.

Orca 4064WF

Pressure Sensitive Decaling - Front

Description: This process is used to apply a laminate and mount adhesive to a graphic at the same time. Commonly referred to as a “decal” it makes a sticker out of the graphic. Once this process is completed the graphic can then be mounted to whatever substrate based on the application and type of mount adhesive used.

Applications this process can create: POP signage, Floor Graphics, Window signage, Countertop graphics, Cooler Signage, and many more...

Materials that can be used with this process: Any Arctic Laminate and any single release liner Arctic Mounting Adhesive.

Procedure

Step 1: Load roll of PSA laminate on top unwind and roll of PSA mount adhesive on bottom unwind.

Step 2: Lower or remove any tables. The rollers should be in the up position.

Step 3: Pull laminate under the idler toward the front of the laminator and attach it to the rewind. Rotate rewind one revolution to wrap film around it.

Step 4: Using a sharp blade, score the laminate to separate it from the release liner.

Step 5: Drape the laminate across the top main roller.

Step 6: Pull the PSA mount adhesive straight up toward the main rollers. Attach the two materials together.

Step 7: Raise or replace any tables on the laminator.

Step 8: Insert a leader board into the roller gap and lower the rollers down to the thickness of the leader board. Press start.

Step 9: Continue the leader board through the laminator until it exits the rollers. Lower the rollers to the lamination setting. Adjust film tensions as needed. Check output for quality. Press stop.

Step 10: Press start and proceed with laminating graphics.

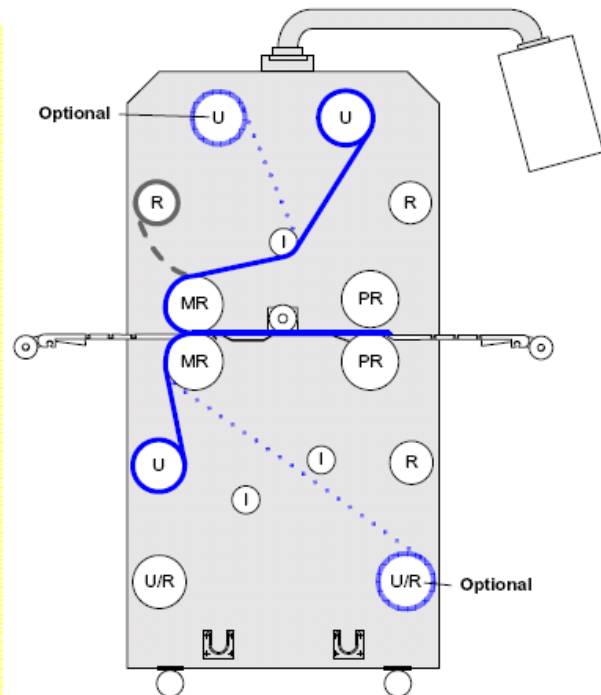
**Hints:**

- Use only one piece of tape in the middle when attaching the laminate to the rewind. This will allow the material to shift if necessary and make it easier to remove the liner later.
- When webbing the top laminate, make sure the edges of the laminate line up from the unwind to rewind to laminating roller. This will ensure the material is feeding straight.
- If the laminate starts to follow the release liner toward the rewind, either reduce tension on the rewind or increase tension on the unwind. If the release liner follows the laminate into the laminating rollers, increase tension on the rewind.
- The use of the pull rollers is optional. Using them will help pull the material out the back of the laminator. Reduce the clutch tension if using them. This will prevent stretching of the laminate and help reduce curl.

Orca 4064WF

Pressure Sensitive Mounting - Decal - Front

Description: This process is used to mount a decal to a substrate. A decal is a graphic that has a pressure sensitive mount adhesive on it.

Applications this process can create: POP signage, Rigid Outdoor and Indoor signs, Presentation Graphics, Legal Graphics, and many more...

Materials that can be used with this process: Any material or graphic with a pressure sensitive mount adhesive on it.

Procedure

Step 1: Set the main roller gap to the thickness of the substrate. Raise the pull rollers. Leave the table in place.

Step 2: Pull 1" - 2" of release liner off the decal, slightly crease and place on the substrate with adhesive facing the substrate. Line it up with the edges of the board, starting in the middle tack the leading edge of the decal to the substrate.

Step 3: Insert board into roller gap making sure it is entering the rollers straight.

Step 4: Using the foot pedal, feed the board into the rollers to the point of separation between the liner and decal.

Step 5: Place the decal over the roller and through to the back of the laminator.

Step 6: Place one hand on top of the roller to hold the print and with the other grab hold of the release liner.

Step 7: Press the foot pedal. As the materials feed into the rollers pull the release liner off the decal.

Step 8: Continue until the decal and substrate has exited the rollers.

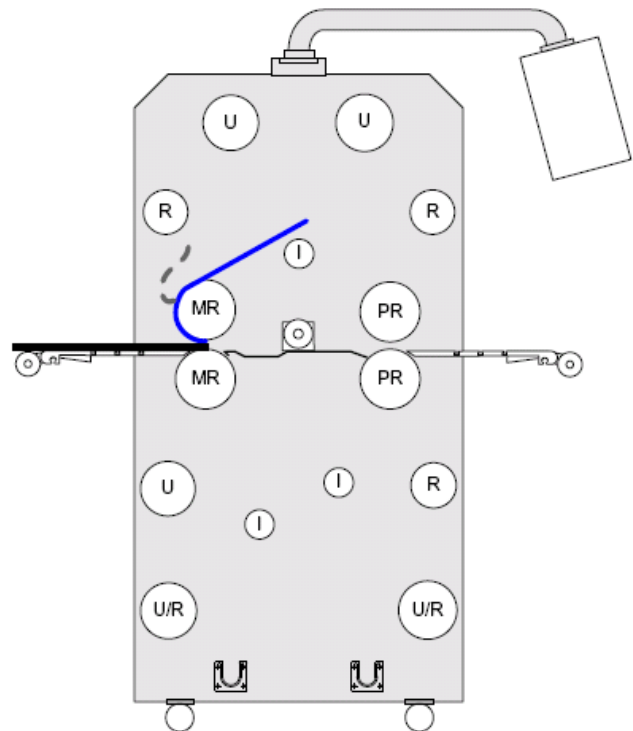

Hints:

- For larger graphics, a second person in the back can help apply tension to the decal. This will free up the person in front to perform any cleaning of the materials.
- Make sure to raise the pull rollers for this process. If the pull rollers are down it can sometimes cause damage to the leading edge of the board.
- If the release liner gets caught in the rollers, do not panic. Sometimes the materials can be reversed out until the release liner is free without damaging the decal.
- Do not allow the materials to stop under the pressure of the rollers for any extended period. This can cause an indentation on softer substrates.

SPEED / TEMPERATURE CONTROL

This is only a general reference guide. Different settings may be suitable as the warm up time, lamination time and materials change.

Factors that may affect the speed and temperature parameters;

1. Image length thickness
2. Image width and ink coverage
3. Ink coverage
4. Paper type
5. Laminate thickness
6. Operating environment
7. Condition of the rollers
8. Line voltage (effects heaters)
9. Using cooling features.

You may have to adjust temperature or speed depending on stock finish, *Turn heat off when not in use.

NIP ROLLERS SHIM DIAL Adjustment

The Nip Setting has the following choices.

“LAM”, 0”, 1/16th”, 1/8th”, 3/16th”, 1/4th”, 3/8th”, 1/2th”, 3/4th” & 1”

The “LAM” Setting is used in applications where full pressure is desired. The “LAM” is used for some applications like Pressure sensitive or Encapsulation where thick material is being laminated and better edge seal is needed.

The “0” setting is used in most general encapsulation applications, especially when laminating wide thin materials.

The “0” setting provides a positive stop on the downward pressure regardless of the Pneumatic downward pressure. The positive Stop helps to create the most consistent even Nip foot print across the roll.

The “0” setting is adjusted and set with the Main rolls cold, a small amount of light is visible between the rolls about 5” in from each end.

THE ART OF LAMINATION**BASIC RULES**

- Do not attempt to laminate abrasive or metal Objects such as staples, paper clips and glitter, as they may damage the heat or pull rollers.
- Do not force items into the nip area of the heat rollers. An item that is not easily drawn into the laminator by the heat rollers is probably too thick to laminate.
- Wrinkles may result if an attempt is made to reposition an item once it has been grasped by the heat rollers.
- Do not stop the laminator before an item has completely exited the pull rollers. Even a momentary stop will cause a mark (heat line) on the laminated item.

Good, consistent lamination is a result of combining proper heat, tension and dwell time. Dwell time is controlled by the speed of the motor and is defined as the amount of time the material to be laminated is compressed between the heat rollers.

As a general rule, thicker items and film need to run at slower speeds because they extract more heat from the rollers at a quicker rate. Setting the speed control at slower settings gives the laminator longer dwell time thus allowing proper lamination of thick items. Thinner items, such as standard copier paper (20 lb. bond) and tissue paper, extract less heat from the rollers and can be run at faster speeds.

FILM TENSION

Proper film tension, known as brake tension, is the minimum amount required to eliminate wrinkles in the finished item. The film should be taut. A properly adjusted roll of film should not require excessive force to turn by hand.

Film tension should be enough to introduce a minor amount of drag as the film unrolls. Insufficient tension causes wrinkles, while too much tension causes stretching (necking). Uneven tension between the top and bottom rolls creates curl. Too much upper tension creates upward curl.

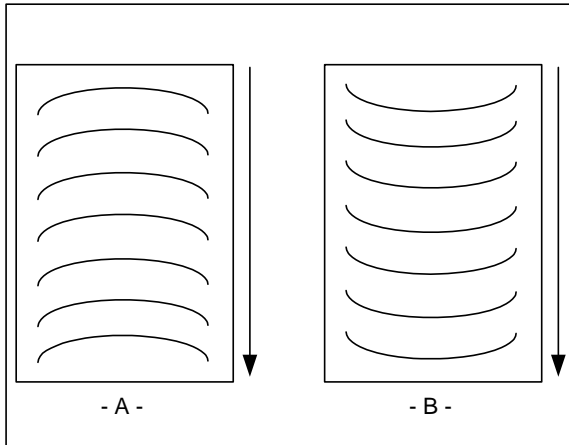

FIGURE 39

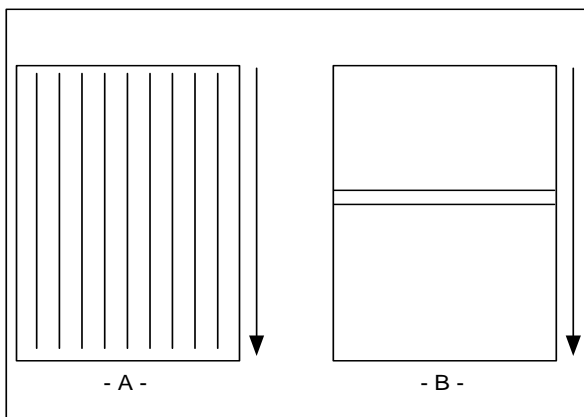

FIGURE 40

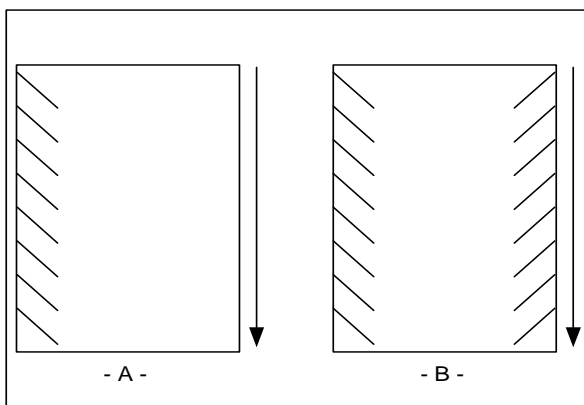

FIGURE 41

Heat

The "READY" indicator may extinguish if the speed is set too fast for the material being laminated. Either lower the speed setting or press STOP () and wait until the "READY" indicator illuminates. Operation of the laminator for more than thirty minutes at a time may necessitate a lower speed setting. It is recommended that, during periods of long runs, the items being laminated are alternated between thick and thin. Do not combine thick and thin items at the same time, as this will result in a poor edge seal around the thinner material. If you are unsure that the laminator is set at the proper speed for the item to be laminated, run a test piece (scrap) of the same or similar material through the Laminator. This procedure is recommended because rotating the heat roller prior to lamination will more evenly distribute the heat.

Make speed adjustments if necessary.

Output

- "D" waves in the image (Fig. 39 A).
 - Check paper tension.
 - Paper may be damp or not dry.
- "D" waves in the laminate (Fig. 39 B).
 - Check main roller pressure.
 - Check pull roller pressure.
- Straight waves in output (Fig. 40 A).
 - Check operational settings for materials being used.
 - Check clutch tension.
- Indent waves in output after pull rollers
 - Insufficient cooling time.
 - Output was handled prior to cooling.
 - Use cooling feature if not on.
 - Machine was stopped on print.
- Angled waves in the output
 - Main air Supply setting
 - Check main Roller Pressure.
 - Check main roller pressure.
 - Check pull roller pressure.
 - Check for Paper Tension.

MAINTENANCE**Caring For The GBC 4064WF-1 Laminator**

GBC offers Cleaning kits as well as Extended Maintenance Agreements.

Contact your local GBC Service Representative or your dealer/distributor for additional information. The only maintenance required by the operator is to periodically clean the heat rollers and schedule semi annual maintenance checks. The following procedure will help keep the heat rollers free of adhesive that has been deposited along the edge of the laminating film. Proper alignment of the rolls of film reduces the amount of “squeeze out”.



WARNING: Do not attempt to laminate adhesives marked “Flammable”.
Do not laminate glitter and/ or metallic items. Damage to the rollers may result.



WARNING: Do not apply any cleaning fluids or solvents to the rollers. Some solvents and fluids could ignite on heated rollers.
Never clean rollers with sharp or pointed objects.
Hardened adhesive deposits on the rollers can cause damage to the rollers. Rotate the rollers at the lowest speed setting on the control panel.



CAUTION: THE FOLLOWING PROCEDURE IS PERFORMED WHILE THE LAMINATOR IS HOT. USE EXTREME CAUTION.

1. Remove the film from the laminator following the Procedure outlined in steps 1 through 6 of the section entitled TO UNWEB THE LAMINATOR.
2. Preheat the laminator until the “READY” indicator illuminates.
3. Tilt the feed table.
4. Rub the top and bottom heat rollers with a 3M™ Scotch-Brite™ pad. DO NOT USE METAL SCOURING PADS!
5. Use the footswitch to rotate the lower heat/ pull roller to an unclean portion. The upper heat/ pull rollers are free spinning. Continue this process until the complete surfaces of both rollers are clean.
6. Refer to the beginning of the section entitled OPERATING INSTRUCTIONS to web your laminator.

NOTE: Do not use metal scouring pads to clean the rollers.

TROUBLE SHOOTING GUIDE

SYMPTOM	POSSIBLE CAUSE	CORRECTIVE ACTION
The control panel display does not illuminate when POWER ON/OFF is in the ON, marked "I", position	Laminator not connected to electrical supply	Insert attachment plug into receptacle
	Blown out fuse.	Check fuses.
Heat rollers do not turn when I	Feed table not properly installed.	Tilt feed table and properly replace it.
Press the RUN () button.	Pull E-Stop button	Pull out on the E-STOP push button.
Heat rollers only turn if I use the "Footswitch".	Photo eye is blocked.	Disengage the footswitch mode. Clear nip area.
Laminated items exhibit curling.	Tension between the top and bottom film. Roll is unequal.	Adjust tension per section FILM TENSION.
	Tension on top or bottom roll of film is too film is too loose.	Adjust tension per section FILM TENSION.
	Bottom film roll may be improperly loaded.	Make sure bottom roll of film is around idler bar and that is the normal operation position.
Adhesive deposited on heat rollers.	Top and bottom film webs not aligned	Release heat and pull roller pressure, align the rolls of film.
	Laminate improperly loaded.	Adhesive (matte) side of laminate film may be against the heat rollers. Unweb and reload the film properly.
Unsatisfactory adhesion of laminate.	Speed setting too fast for type of material being laminated	Lower speed setting.
	Insufficient heat	Wait for "READY" indicator to appear in the control panel display.
	Laminate improperly loaded	Adhesive side of film must be facing away from the heat rollers.
	Heat rollers require cleaning.	Bottom roll of film not threaded behind the idle bar.
	Laminated item unsuitable for adhesion.	Clean heat rollers per procedure in section CARING FOR THE GBC 4064WF-1 LAMINATOR. Item may be dirty or may have non porous surface that is extremely difficult to laminate.

SERVICE AGREEMENT

GBC's Equipment Maintenance Agreement will insure the quality performance and long life built into your laminator.

A service charge for travel time, labor and parts may be incurred for each out of warranty service call. GBC's Equipment Maintenance Agreement

Decreases these expenses and protects your valuable investment. GBC offers several types of agreements to suit your needs and budget. To contact

GBC/ACCO write to:

ACCO Brands Inc.
300 Tower Parkway
Lincolnshire, IL 60069

IN CANADA:

GBC NATIONAL SERVICE
49 RAILSIDE ROAD
DON MILLS, ONTARIO
M3A 1B3